

Price list

DKK – Valid from 01.01.2023

HAG

Celebrating movement



Table of contents

General sales and delivery terms	3
HÅG SoFi® - task chairs	6
HÅG SoFi® - communication chair	8
HÅG Capisco® - task chair	9
HÅG Capisco Puls® - task chair	11
HÅG® Tion - task chair	13
HÅG Futu® - task chair	15
HÅG Futu® - communication chair	16
HÅG executive collection - Fabrics and Colours	17
HÅG® Tribute - task chair	19
HÅG® Tribute - meeting chair	20
HÅG® Excellence - task chair	21
HÅG® Excellence - meeting chair	22
HÅG® Inspiration - task chair	23
HÅG® Inspiration - meeting chair	24
HÅG Creed® - task chair	25
HÅG Creed® - communication chair	27
HÅG H03® - task chair	28
HÅG® Celi - conference chair	29
HÅG Conventio® - conference chair	31
HÅG Conventio Wing® - conference chair	33
HÅG Accessories	35
Main Spare Parts	36
Physical Measurements - HÅG task and meeting chairs	43
Physical Measurements - HÅG conference chairs	48
Product Tests	49
Environmental Certificates	50
HÅG Fast	51
HÅG Fabrics and Colours (FutuKnit)	52
HÅG Fabrics and Colours PLASTIC & METAL	53
HÅG Standard fabrics & colour collection 2023	56
Curated Fabric & Colour Collection	64
Extended Fabric & Colour Collection	65

General sales and delivery terms

This document applies for contracted distributors of HÅG in Denmark (including Faroe Islands and Greenland).

STANDARD DELIVERY TIMES

Standard dispatch times from factory	Working days
Fast Fabric & Colour Collection	5-10
Standard Fabric & Colour Collection	10-15
Curated Fabric & Colour Collection	15-20
Extended Fabric & Colour Collection	25-30*
Special and COM	on request

2-3 transport days to be added on top of production lead time.

* Provided that the supplier has the fabric in stock.

Longer delivery times may occur periodically, during holidays and for large orders.

Larger orders with polished and tumbled (HÅG Tion only) aluminium, wood back/seat or 3D armrests specified may cause longer lead times.

ORDER ENTRY SPECIFICATIONS

When placing your order please remember to specify the following information:

- Chair model
- Number of chairs
- Fabric/Leather and Colour Code
- Plastic colour on HÅG Capisco Puls, HÅG Conventio Wing and HÅG Celi
- Colour on seat&back, back stem, lift, five star base, (armrests optional) on HÅG Tion
- Colour of base
- Type of castors or glides
- Delivery date
- Delivery address

Colour on base

Where a base is specified in black, other metal components will also be in black, if not specified in other colours. Similarly, chairs on silver bases have metal components in silver. Other metal colours need to be specified for chairs with polished aluminium bases (extra cost option). Specified combinations are defined for:

- HÅG SoFi
- HÅG executive

Castors

Both hard and soft castors and glides are supplied according to EN 1335 Class A standard, and must be specified at time of order (soft for hard flooring, hard for soft flooring). Additional castor options are available on request, but must be specified at time of order and the delivery lead time may be increased. Price on application.

PRICES

All prices in DKK exclusive of VAT. Valid from 01.01.2023. Quotations are valid for 30 days unless otherwise agreed.

Any typographical errors shall not be binding for Flokk and will be subject to correction without liability to the vendor.

CONDITION OF DELIVERY

Ex Works (Incoterms 2020), including packaging. A 3% transportation & energy cost surcharge on the net order value will be applied to all orders with delivery terms agreed different from Ex Works.

Shipping fee of 5% of the net order value (min. DKK 250) is added on all orders, which is not delivered to addresses used or owned by the distributor.

Time specific delivery on a specific date and time indication costs DKK 5.000 per. order and must be ordered no later than five days before the sending date via Customer Service, Flokk A/S.

Visible transport damage and discrepancies in the number of items received must always be noted on the bill of carriage at the time of receipt and reported to the carrier. Invisible transport damage (damaged product, but not package) should be reported in writing to Customer Service, Flokk A/S within 7 days.

CHANGE/CANCELLATION OF ORDERS

Change/cancellation of orders on chairs or upholsteries is possible up until production has begun. Changing / canceling orders from the "HÅG Fast" collection is not possible.

Each amended or cancelled order will incur a charge:

- Amended order (all changes & cancellations) before production start will incur a charge of 500 DKK per order
- Amended order & cancellations after purchasing has started will incur a charge of 750 DKK per order + cost of materials

For further information regarding change/cancellation of orders, please feel free to contact Customer Service, Flokk A/S.

HÅG WARRANTY

General terms and conditions

Flokk's warranty covers all HÅG chairs against material and manufacturing faults and defects from the chair's production date. The warranty covers any necessary spare parts. Labour and transport costs are not covered. Wear and tear must be expected from normal use and are not covered by the warranty. Unless otherwise is specified, the maximum weight for users is 110 kg. The warranty is conditional on the chair and fabrics/leather undergoing normal cleaning. The warranty does not cover the consequence of wear and stains when choosing a light (white) colour for upholstery, plastic or metal components.

10 year warranty for HÅG products and accessories

Flokk provides a 10 year warranty for all HÅG chairs and accessories that are in normal use for up to 9 hours per day. Please also see the general warranty terms and conditions.

24/7 – 5 year warranty

Flokk provides a 5 year warranty for HÅG chairs that are specifically purchased for 24 hour use and which are upholstered in 24/7 approved fabric/leather from Flokk's Standard & Extended Collection. Please also see the general warranty terms and conditions.

>9 hours/day – 5 year warranty

Flokk provides a 5 year warranty for all HÅG chairs that are in normal use for more than 9 hours per day. Please also see the general warranty terms and conditions.

Spare parts guarantee

Flokk guarantees the delivery of spare parts for a minimum of 10 years after the chair's production date. The guarantee covers the parts necessary to maintain the chair's original functionality.

FABRIC AND COLOUR COLLECTION

Standard Fabric & Colour collection

Flokk provides a 10 year warranty for fabrics/leather from the Standard collection when the chair is in normal use for up to 9 hours per day, except Illusion and PUxx1 where Flokk provides 5 year warranty. Flokk provides a 5 year warranty for fabrics/ leather from the Standard collection when the chair is in normal use for more than 9 hours per day, except for Illusion and PUxx1 where a 2 year warranty is provided.

Curated Fabric & Colour collection

Flokk provides a 10 year warranty for fabrics from the Curated collection when the chair is in normal use for up to 9 hours per day. Flokk provides a 5 year warranty for fabrics from the Curated collection when the chair is in normal use for more than 9 hours per day.

Extended Fabric & Colour collection

Flokk provides a 5 year warranty for fabrics/leather from the Extended collection when the chair is in normal use for up to 9 hours per day. Some of the fabrics in the Extended collection are available with a 5 year warranty for 24 hour use (for use of more than 9 hours per day).

Special or Customer specified fabrics/leather

If the fabrics in the Standard, Curated or Extended collections are not what you are looking for, please contact Customer Service, Flokk A/S. When choosing Special or Customer specified fabric/leather the general warranty terms and conditions are still valid, except for the upholstery which will be without any warranty. This does not affect your rights and obligations under local law. Customer specified fabrics/leather can only be used following approval by Flokk.

Fabrics and leathers that are not tested on our products, need to have an upholstery test before we can approve it and the order can be registered. Cost (DKK 1.545) for testing will be charged.

MAINTENANCE GUIDE

Care of fabric upholstery

Regular vacuum cleaning is recommended. Vacuum clean the chair with a furniture brush or wipe it with a clean white cloth or sponge slightly dampened with lukewarm, clean water. Marks and stains should be removed with a proprietary cleaner.

Care of leather upholstery

Wipe with a slightly damp cloth and gently rub dry. A good proprietary hide food should be applied at least once a year and more often if the leather is in a dry atmosphere or close to a heat-source.

Do not remove any plastic parts or attempt to open the seating mechanism. For additional maintenance advice please contact our customer service team or our web site flokk.com.

Care of gas stem

Gas stems should be periodically wiped clean with a cloth and general purpose solvent, then a fingertip of light grease applied.

APPROVALS AND CERTIFICATIONS

Flokk is ISO 9001 accredited. The German test institutes, LGA and Intertek, have approved and issued the GS certificate (Geprüfte Sicherheit) for a number of HÅG products.

- The majority of HÅG task chairs are tested in accordance with both EN 1335 Type A (European office chair standard) and ANSI Bifma (American standard).
- The majority of HÅG conference and visitor chairs are tested in accordance with EN 16139 and the ANSI Bifma standard.
- HÅG SoFi, HÅG Futu and HÅG executive are tested according to British Standard BS 5459-2, a commonly used standard for intensive use (24 hours).

EN 1335 is a European Standard for office chairs and considers dimensions of the chair, safety requirements and safety test methods. The European Standard tests are based on 8 hours daily use by persons weighing up to 110 kg.

The British Standard (BS 5459-2) tests that the chair will be suitable for more than 8 hours daily use and for persons weighing up to 150 kg

The majority of HÅG products are certified with the Swedish Möbelfakta and GREENGUARD Gold, while a selection of HÅG products are certified with the Nordic Swan Ecolabel.

DISCLAIM

Flokk disclaims any responsibility for products that are configured or assembled in a different way than Flokk's official configurations. That is, as a result of component purchases, special orders or the like.

ESD (ELECTROSTATIC DISCHARGE)

We can supply HÅG Creed 6002, HÅG Creed 6004, HÅG Capisco Puls 8001/8010 and HÅG Capisco 8106 as ESD chairs upholstered in anti-static synthetic leather (Nevotex) or Global ESD (Bogesunds) in price group 6 +10%. For HÅG Capisco Puls the price will be price group 5 + 25%. Flokk provides a 5 year warranty on ESD chairs, conditional on castors and upholstery being cleaned regularly with a suitable cleaning agent. The ESD models are only available in silver painted aluminium. The ESD models are always delivered fully assembled.

CLEAN-ROOM

We can supply HÅG models with vinyl that are suitable for areas that need to be regularly cleaned. Please contact Customer Service for further information. HÅG Capisco Puls 8010 upholstered in anti-static synthetic leather by Nevotex (price group 3) approves an air cleanliness test according to ISO 14644, class 4-5.

Flokk provides a 5 year warranty on clean-room chairs, conditional on castors and upholstery being cleaned regularly with a suitable cleaning agent.

HEALTHCARE

We recommend PUxx by Oniro and Illusion by Nevotex. Both are easy cleanable polyurethane based synthetic leather for use within healthcare. PUxx and Illusion are easy to disinfect with alcohol, chlorine or hydrogen peroxide solutions. PUxx1 colour 215816 is available as standard in price group 3 and Illusion colour 110 is available as standard in price group 4. PUxx is not available for HÅG Conventio, HÅG Capisco Puls 8002/8020.

FIRE RESISTANCE FOAM

All foam is HR source 0 and 1 approved. CMHR foam is available on request at a 750 DKK surcharge (340 DKK HÅG Tion, HÅG Celi, HÅG Capisco Puls, HÅG Conventio and HÅG Conventio Wing), but must be specified at time of order and adds approximately two to five weeks to delivery lead times. CMHR foam with source 5 fabric must be specified on chairs intended for domestic use.

Please contact Customer Services for further information.

ENVIRONMENTAL RESPONSIBILITY

Environmental considerations on our products and the manufacturing of our products are at the heart of our business. Flokk is thus certified in accordance with ISO 14001:2015 environment and ISO 50001:2018 energy management systems. Most of the materials used in HÅG products can be recycled if handled properly. A complete material composition for each HÅG product is available on request.

PACKAGING MATERIAL - RECYCLING

We encourage you to ensure recycling of all packaging material. Please sort and return the packaging material, using your local recycling partners/stations - and follow your local regulations.

If you have questions on how to handle waste packaging material, please inform your contact person within Flokk.

END OF LIFE - RECYCLING

We encourage you to ensure proper recycling of your chair and its various components. Please dispose of your chair/components using your local recycling partners/stations - and follow your local regulations. If you have questions on how to dispose or return your chair after use, please inform your contact person within Flokk.

CUSTOMER SERVICE

Flokk A/S

Phone: +45 99 50 55 00

E-mail: info-dk@flokk.com

Monday - Wednesday 08.00 - 16.00



Thursday 09.00 - 16.00

Friday 08.00 - 15.00

Flokk reserves the right to make small construction alterations without notice.

HÅG SoFi® - task chairs

- HÅG inBalance® (balanced, flowing tilt function backwards and forwards)
- Seat depth adjustment
- Seat height adjustment
- Adjustable lumbar support
- Adjustable tilting resistance forwards and backwards
- Lockable tilt
- Five star aluminium base (730 mm): Black, silver or white, optionally in polished aluminium. Mechanism cover is black when ordering black base. It's light grey when ordering silver or white base. Please specify when placing your order
- Castors for hard or soft flooring. Must be specified at time of order
- 165 mm lift (seat height: 397-546 mm)
- Painted aluminium colours: Black, silver or white
- Plastic colours: Black or light grey

Item no	Base model +	Price Group (PG)	Price Group							Price
			①	②	③	④	⑤	⑥	⑦	
7500	HÅG SoFi 7500 • Mesh back: The mesh back comes in black (MEH001) or grey (MEH002) • High back		7 642	7 853	8 204	8 617	9 017	10 255	11 998	
7200	HÅG SoFi 7200 • Fully upholstered back • Medium back		7 642	7 853	8 204	8 617	9 017	10 255	11 998	
7300	HÅG SoFi 7300 • Fully upholstered back • High back		8 135	8 352	8 721	9 157	9 573	10 859	12 705	

Accessories/Options/Surcharges:

	Headrest HÅG SoFi	1 867	1 906	1 974	2 052	2 129	2 448	2 864
	Adjustable armrests in plastic with soft tops (width 92 mm) and stem in painted aluminium							1 678
	- Surcharge for armrests in painted aluminium with soft tops (width 102 mm) and stem in aluminium							322
	- Surcharge for armrests in black plastic with soft tops (width 92 mm) and stem in polished aluminium							1 289
	- Surcharge for armrests in polished aluminium with soft tops (width 102 mm) and stem in polished aluminium							1 611
	- Surcharge for armrests with leather tops, black or dark grey (for armrest in aluminium, width 102 mm)							716
	- Surcharge for HÅG SlideBack (available for all armrests)							416
	- Surcharge for armrests with 3D tops (for armrest in plastic)							414
	200 mm lift							110
	Five star base (Ø730 mm) in polished aluminium							702
169121	HÅG FootRing ¹							1 095
	Coat hanger, black or light grey plastic. Not applicable with headrest. (Only for: 7500)							440
	Decorative stitching							888



NB: PRICES MAY VARY WHEN OPTIONS ARE PURCHASED SEPARATELY FROM COMPLETE CHAIRS



[1] Must be ordered together with 200 mm lift.

HÅG SoFi® - communication chair

- HÅG inBalance® (balanced, flowing tilt function backwards and forwards)
- Seat depth adjustment
- Seat height adjustment
- Lumbar support
- 4 star base in aluminium (Ø785 mm): Black, silver or white, optionally in polished aluminium. Mechanism cover is black when ordering black base and light grey when ordering silver or white base. Please specify when placing your order
- Plastic glides for soft flooring or felt glides for hard flooring. Must be specified at time of order
- 165 mm lift (seat height: 397-546 mm)
- Painted aluminium colours: Black, silver or white
- Plastic colours: Black or light grey

Item no	Base model +	Price Group (PG)	Price Group							Price
			①	②	③	④	⑤	⑥	⑦	
7502	HÅG SoFi 7502 <ul style="list-style-type: none"> • Mesh back: The mesh back comes in black MEH001 or grey MEH002. • High back 		6 089	6 221	6 439	6 693	6 944	7 985	9 342	
7202	HÅG SoFi 7202 <ul style="list-style-type: none"> • Fully upholstered back • Medium back 		6 089	6 221	6 439	6 693	6 944	7 985	9 342	
7302	HÅG SoFi 7302 <ul style="list-style-type: none"> • Fully upholstered back • High back 		6 673	6 812	7 051	7 334	7 607	8 748	10 236	

Accessories/Options/Surcharges:

Adjustable armrests in plastic with soft tops (width 92 mm) and stem in painted aluminium	1 678
- Surcharge for armrests in painted aluminium with soft tops (width 102 mm) and stem in aluminium	322
- Surcharge for armrests in black plastic with soft tops (width 92 mm) and stem in polished aluminium	1 289
- Surcharge for armrests in polished aluminium with soft tops (width 102 mm) and stem in polished aluminium	1 611
- Surcharge for armrests with dark grey leather tops (for armrest in aluminium only)	716
Four star base (Ø785 mm) in polished aluminium	702
Five star base (Ø730 mm) in aluminium - silver/black/white	0
Five star base (Ø730 mm) in polished aluminium	702
Decorative stitching	888

NB: PRICES MAY VARY WHEN OPTIONS ARE PURCHASED SEPARATELY FROM COMPLETE CHAIRS

Decorative stitching is available for all models, but only for the seat on HÅG SoFi with mesh back.

HÅG Capisco® - task chair

- HÅG inBalance® (balanced, flowing tilt function)
- Adjustable tilt tension backwards (not available for 8105)
- Seat height adjustment
- Seat depth adjustment (not available for 8105)
- Back height adjustment (not available for 8105)
- Lockable seat (not available for 8105)
- Suitable for all working surfaces with table height of 72 cm and higher
- Five star base in aluminium (Ø730 mm) with curved/arched footplates, black, silver or white, optionally in polished aluminium (see options below). Please specify colour at time of order
- 200 mm lift (seat height: 470-655 mm). 265 mm lift standard for 8105 (seat height: 530-790 mm)

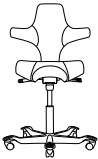
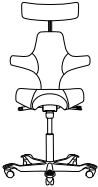
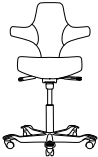
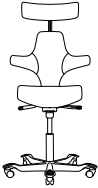
Item no	Base model +	Price Group (PG)	Price Group							Price
			①	②	③	④	⑤	⑥	⑦	
8105	HÅG Capisco 8105		4 085	4 159	4 357	4 569	4 774	5 353	6 263	
8106	HÅG Capisco 8106 • Available as electrostatic discharged (ESD) chair (PG 6 + 10%)		10 310	10 503	10 994	11 314	11 823	13 090	15 316	
8107	HÅG Capisco 8107 • Headrest (only available in silver and black)		12 350	12 690	13 318	13 817	14 558	16 407	19 196	
8126	HÅG Capisco 8126		10 310	10 503	10 994	11 314	11 823	13 090	15 316	
8127	HÅG Capisco 8127 • Headrest (only available in silver and black paint)		12 350	12 690	13 318	13 817	14 558	16 407	19 196	

Accessories/Options/Surcharges:



	150 mm lift	0
	200 mm lift	0
	265 mm lift (glides are recommended, no additional charge)	101
	Telescopic lift cover (200mm & 265mm)	90
	Five star base (Ø730 mm) in polished aluminium	839
	Universal castors Ø65 mm, for hard and soft floors, black	82
169121	HÅG FootRing ¹	1095
165177-1A/2A	HÅG StepUp 1 pcs	1392
165134	HÅG Quickstep, 1 pcs	992
	Decorative stitching (Only for: 8105, 8106, 8107)	888

NB: PRICES MAY VARY WHEN OPTIONS ARE PURCHASED SEPARATELY FROM COMPLETE CHAIRS

[1] Must be ordered together with 200 mm or 265 mm lift.

HÅG Capisco Puls® - task chair

- HÅG inBalance® (balanced, flowing tilt function)
- Adjustable tilt tension backwards (not available for 8001 and 8002)
- Seat height adjustment
- Seat depth adjustment (not available for 8001 and 8002)
- Back height adjustment (not available for 8001 and 8002)
- Lockable seat (not available for 8001 and 8002)
- Seat and backrest available in 9 different colours: Clay, Pink, Sea Green, Petroleum, Light Grey, Black, White, Red and Brown. Please specify colour at time of order. Brown is made of recycled PP from snow plough markers - colour variations between batches may occur due to mix of black and red plough markers
- For ESD models, seat and back are only available in black
- Five star base (Ø730 mm) in aluminium with curved/arched footplates, black, silver or white, optionally in polished aluminium. Please specify colour at time of order

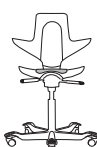
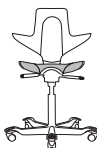
Item no	Base model +	Price Group (PG)	Price Group							Price
			①	②	③	④	⑤	⑥	⑦	
8001	<p>HÅG Capisco Puls 8001</p> <ul style="list-style-type: none"> • Pad available in all Standard Fabrics except Steelcut 3, Steelcut Trio 3, Sirdal & Suldal • Seat height: 540-770 mm • 265 mm lift • Available as electrostatic discharged (ESD) chair (PG 5 +25 %) 		2 608	2 652	2 766	2 902	3 033	3 488	4 081	
8002	<p>HÅG Capisco Puls 8002</p> <ul style="list-style-type: none"> • Removable seat cushion available in all Standard Fabrics • Seat height: 555-785 mm • 265 mm lift 		3 479	3 554	3 678	3 800	3 941	4 532	5 303	
8010	<p>HÅG Capisco Puls 8010</p> <ul style="list-style-type: none"> • Pad available in all Standard Fabrics except Steelcut 3, Steelcut Trio 3, Sirdal & Suldal • Seat height: 455-640 mm • 200 mm lift • Available for Cleanroom upholstered in Antistatic synthetic leather • Available as electrostatic discharged (ESD) chair (PG 5 +25 %) 		3 747	3 819	3 992	4 104	4 285	4 928	5 766	
8020	<p>HÅG Capisco Puls 8020</p> <ul style="list-style-type: none"> • Removable seat cushion available in all Standard Fabrics • Seat height: 470-650 mm • 200 mm lift 		4 218	4 308	4 460	4 611	4 782	5 500	6 434	

Accessories/Options/Surcharges:

	150 mm lift	0
	200 mm lift	0
	265 mm lift (glides are recommended, no additional charge)	101
	Telescopic lift cover (200mm & 265mm)	90
	Five star base (Ø730 mm) in polished aluminium	839
	Universal castors Ø65 mm, for hard and soft floors, black	82
169121	HÅG FootRing ¹	1095
165177-1A/2A	HÅG StepUp 1 pcs	1392
165134	HÅG Quickstep, 1 pcs	992

NB: PRICES MAY VARY WHEN OPTIONS ARE PURCHASED SEPARATELY FROM COMPLETE CHAIRS

Electrostatic discharged (ESD) chair: Seat and back only available in black

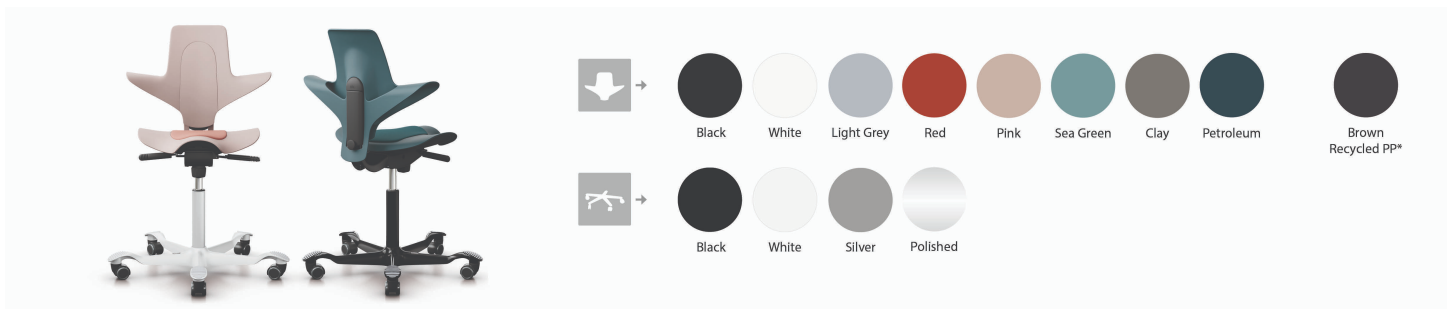





*Colour variations between batches may occur

[1] Must be ordered together with 200 or 265 mm lift

HÅG® Tion - task chair

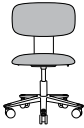
- HÅG inBalance® (balanced, flowing tilt function backwards and forwards)
- Seat height adjustment
- Lockable tilt
- Universal castors (Ø65 mm) for soft and hard flooring, black
- Five star base (Ø620 mm) with foot supports in recycled aluminium. Available in 5 colours (Black, Silver, White, Blush Rose and Moss Grey) and 2 finishes (polished* and tumbled*)
- 150 mm lift (seat height: 408-542 mm). Available in 5 colours (Black, Silver, White, Blush Rose and Moss Grey)
- Back stem in recycled aluminium. Available in 5 colours (Black, Silver, White, Blush Rose and Moss Grey) and 2 finishes (polished* and tumbled*)
- Seat and back in 94% post-consumer recycled PP or Ash with white pigmented wax. PP available in 7 colours (Black, Mist, Harvest, Moss, Blush, Chestnut and Crowberry).
- Please specify colours at time of order - on seat&back, back stem, five star base and lift. See colour palette on next page for possible combinations
- Focus collection - see below Accessories/Options. A selection of sustainable fabrics with colours from Standard and Extended collection that matches the HÅG Tion

Item no	Base model +	Price Group (PG)	Price Group							Price
			①	②	③	④	⑤	⑥	⑦	
2100	HÅG Tion 2100 • Plastic seat and back • Seat height: 408-542 mm									3 688
2140	HÅG Tion 2140 • Upholstered seat and plastic back • Removable upholstery • Seat height: 408-542 mm		4 295	4 412	4 467	4 506	4 633	5 328	6 234	
2160	HÅG Tion 2160 • Upholstered seat and back • Removable upholstery • Seat height: 408-542 mm • Paloma/Paloma Soft not available		4 837	4 941	5 114	5 319	5 515	6 343	7 420	
2200	HÅG Tion 2200 • Wooden seat and back • Seat height: 408-542 mm									7 596
2240	HÅG Tion 2240 • Upholstered seat and wooden back • Removable upholstery • Seat height: 408-542 mm		6 715	6 859	7 099	7 383	7 656	8 805	10 301	

Accessories/Options/Surcharges:

	Armrests in painted aluminium. Black, Silver, White, Blush Rose or Moss Grey	687
	Armrests in tumbled aluminium	982
	Armrests in polished aluminium	1176
	Back stem in tumbled aluminium*	104
	Back stem in polished aluminium*	459
	Five star base (Ø620 mm) in tumbled aluminium*	185
	Five star base (Ø620 mm) in polished aluminium*	430
	200 mm lift. Black, Silver, White, Blush Rose or Moss Grey	93
169121	HÅG FootRing in black, silver or white ¹	1095
165177-1A/2A	HÅG StepUp 1 pcs	1392
165134	HÅG Quickstep, 1 pcs	992

NB: PRICES MAY VARY WHEN OPTIONS ARE PURCHASED SEPARATELY FROM COMPLETE CHAIRS

HÅG Tion - Focus collection

① Cura CU60999 (S) Cura CU66165 (S)

③ Cura CU60112 (E) Cura CU62083 (E) Cura CU68261 (E) Cura CU61257 (E) Cura CU61258 (E) Focus Melange FCM60309 (E) Oceanic OCI001 (E) Main Line Flax MLF12 (E)

④ Sirdal SRD190 (S) Sirdal SRD120 (S) Sirdal SRD780 (S) Sirdal SRD960 (S) Sirdal SRD630 (S) Sirdal SRD480 (S) Sirdal SRD210 (E) Sirdal SRD320 (S)

⑥ Sisu SIS165 (E) Sisu SIS805 (E) Sisu SIS405 (E)

⑦ Elmosoft EL33004 (S)

S = Standard
E = Extended

[1] HÅG FootRing must be ordered together with 200 lift

HÅG Futu® - task chair

- HÅG inBalance® (balanced, flowing tilt function backwards and forwards)
- Seat depth and seat height adjustment
- Adjustable lumbar support
- Adjustable forwards and backwards tilting resistance. Lockable tilt
- Aluminium five star base (Ø730 mm) with foot supports, black or silver
- 165 mm lift (Seat height: 400-550 mm)
- Painted aluminium colours: Black or silver - Plastic colours: Black

Item no	Base model +	Price Group (PG)	①	②	③	④	⑤	⑥	⑦	Price
1100-S	HÅG Futu 1100-S • FutuKnit mesh on backrest • FutuKnit solid on seat									6 746
1100	HÅG Futu 1100 • FutuKnit mesh on backrest • Standard or Extended fabric on seat		7 098	7 229	7 473	7 744	8 108	9 131	10 684	
1200-S	HÅG Futu 1200-S • FutuKnit solid on face of backrest • FutuKnit solid on seat • Adjustable lumbar support									6 746
1200	HÅG Futu 1200 • FutuKnit solid on face of backrest • Standard or Extended fabric on seat • Adjustable lumbar support		7 098	7 229	7 473	7 744	8 108	9 131	10 684	



Accessories/Options/Surcharges:

NB: PRICES MAY VARY WHEN OPTIONS ARE PURCHASED SEPARATELY FROM COMPLETE CHAIRS

	200 mm lift	110
	Adjustable armrests, black plastic	1 002
	Adjustable armrests with 3D top (pair)	1 646
	Adjustable armrests with padded black leather top	1 907
	Five star base (Ø730 mm) in polished aluminium	702
	Five star base (Ø670 mm) in black plastic	-354
	Lumbar support (Only for: 1100-S, 1100)	321
169121	HÅG FootRing - Must be ordered together with 200 mm lift	1 095
165134	HÅG Quickstep, 1 pcs	992

HÅG Futu® - communication chair

- HÅG inBalance® (balanced, flowing tilt function backwards and forwards)
- Seat depth adjustment
- Seat height adjustment
- Aluminium four star base (Ø785 mm), black or silver
- 165 mm lift (Seat height: 400-550 mm)
- Painted aluminium colours: Black or silver
- Plastic colours: Black

Item no	Base model +	Price Group (PG)	①	②	③	④	⑤	⑥	⑦	Price
1102-S	HÅG Futu 1102-S • FutuKnit mesh on backrest • FutuKnit solid on seat									5 552
1102	HÅG Futu 1102 • FutuKnit mesh on backrest • Standard fabric or Extended on seat		5 894	6 021	6 259	6 521	6 875	7 868	9 205	

Accessories/Options/Surcharges:

Adjustable armrests, black plastic	1 002
Adjustable armrests with padded black leather top	1 907
Four star base (Ø785 mm) in polished aluminium	868
Five star base (Ø730 mm) in aluminium - silver or black	0
Five star base (Ø730 mm) in polished aluminium	702
Five star base (Ø670 mm) in black plastic	- 354

NB: PRICES MAY VARY WHEN OPTIONS ARE PURCHASED SEPARATELY FROM COMPLETE CHAIRS

HÅG executive collection - Fabrics and Colours

The HÅG executive collection consists of three exclusive product families; HÅG Tribute, HÅG Inspiration and HÅG Excellence. They all include a vast range of features and upholstery that are further explained on the following pages.



HÅG Tribute



HÅG Inspiration



HÅG Excellence

FABRICS

PLAINTECH (SR-WEBATEX)

Used on the rear side of the backrest on HÅG Excellence 9321 and 9331 and HÅG Excellence meeting 9373

Composition:	100 % polyamide
Flammability:	BS EN 1021: 1-2 (Cigarette & match)

SPACE

Space (Gabriel), used on the back of HÅG executive task chairs: HÅG Inspiration 9221 and 9231 and the HÅG Inspiration meeting 9273. This innovative textile is self-supportive, which gives new possibilities regarding product design as well as becoming an important part of the sitting experience.

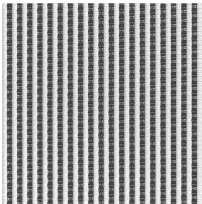
SPACE	
Composition:	100 % polyester monofilament
Abrasion and tear-strength:	2469N x 11083N support strength
Flammability:	BS EN 1021: 1-2 (Cigarette & match), FAR 25.853, DIN 4104 - B1 and B2, BS 5852 P 2 Crib5
Environmental facts:	ISO 14001 certified
Colour:	 <p>Space, SPA 000</p>

For all the above mentioned fabrics the following guarantee and maintenance apply:

- Guarantee: 10 years, 5 years for 24/7 use.
- Maintenance: To be vacuumed with a furniture brush, wiped with a clean damp cloth or sponge slightly dampened with clean lukewarm water.



HÅG executive collection - Fabrics and Colours continued

We offer 4 predefined configurations for the HÅG Executive range:



HÅG Tribute 9031

ALL BLACK (standard)

- Black aluminium foot base - 1
- Black lift cover - 2
- Black armrests - 3
- Black lower part of armrests - 4
- Black lumbar wheel - 5
- Black ring/cover for lumbar wheel - 6
- Black Headrest stem cover - 8
- Black headrest stem - 7
- Black spine - 9
- Black upper and lower back bars - 10



HÅG Excellence 9321



HÅG Tribute 9031

BLACK FOOTBASE WITH DETAILS IN POLISHED AND BLACK ALUMINIUM (option)

- Black aluminium foot base - 1
- Polished lift cover - 2
- Polished armrests - 3
- Polished ring/cover for lumbar wheel - 6
- Polished headrest stem cover - 8
- Black lower part of armrests - 4
- Black lumbar wheel - 5
- Black headrest stem - 7
- Black spine - 9
- Black upper and lower back bars - 10



HÅG Excellence 9321



HÅG Tribute 9031

POLISHED FOOTBASE WITH DETAILS IN POLISHED AND BLACK ALUMINIUM (option)

- Polished aluminium foot base - 1
- Black lift cover - 2
- Black lower part of armrests - 4
- Black lumbar wheel - 5
- Black headrest stem cover - 8
- Black spine - 9
- Polished armrests - 3
- Polished ring/cover for lumbar wheel - 6
- Polished headrest stem - 7
- Polished upper and lower back bars - 10



HÅG Inspiration 9221



HÅG Tribute 9031

ALL POLISHED (option)



- Polished aluminium foot base - 1
- Polished lift cover - 2
- Polished armrests - 3
- Polished lumbar wheel - 5
- Polished ring/cover for lumbar wheel - 6
- Polished Headrest stem cover - 8
- Polished Headrest stem - 7
- Polished upper and lower back bars - 10
- Black lower part of armrests - 4
- Black spine - 9



HÅG Inspiration 9221

HÅG® Tribute - task chair

- HÅG inBalance® (balanced, flowing tilt function backwards and forwards)
- Adjustable forwards and backwards tilt resistance
- Seat height adjustment
- Seat depth adjustment
- Adjustable lumbar support on all models
- Tilt lockable in three positions
- HÅG TiltDown™ armrests (tilt down, height and width) with black leather top
- Five star base (Ø740 mm) with sloping footplates, in matt black aluminium
- All aluminium components are standard black. Optionally 3 combinations are available. Please see specifications at previous HÅG executive collection pages and please specify colour at time for order.
- 150 mm lift (seat height: 387 - 525 mm).

Item no	Base model +	Price Group (PG)	①	②	③	④	⑤	⑥	⑦	Price
9021	HÅG Tribute 9021 • Extra comfort layer gives a more loose upholstery		15 551	15 884	16 439	16 717	17 729	20 390	23 857	
9031	HÅG Tribute 9031 • Adjustable headrest • Extra comfort layer gives a more loose upholstery		18 296	18 687	19 342	20 116	20 858	23 989	28 066	
Accessories/Options/Surcharges:										
	200 mm lift									180
	Without armrests									- 3 665
	HÅG Executive Basic armrests (with height and width adjustment)									- 1 919
	All polished aluminium - only in combination with polished base FB018									1 336
	Mix of black foot base and details in polished aluminium									324
	Mix of polished foot base and details in black painted aluminium - only in combination with polished base FB018									1 128
	Five star base (Ø740 mm), in polished aluminium									828
	Coathanger black (Only for: 9031)									486
	Coathanger polished (Only for: 9031)									589
	Universal castors Ø65 mm, for hard and soft floors, black									82

NB: PRICES MAY VARY WHEN OPTIONS ARE PURCHASED SEPARATELY FROM COMPLETE CHAIRS

HÅG® Tribute - meeting chair

- HÅG inBalance® (balanced, flowing tilt function backwards and forwards)
- Seat height adjustment
- Adjustable back cushion (lumbar)
- Swivel
- Adjustable tilting resistance backwards
- Five star base (Ø650 mm) with sloping footplates, in matt black aluminium
- All aluminium components are standard black. Optionally 3 combinations are available. Please see specifications at previous HÅG executive collection pages and please specify colour at time for order.
- 150 mm lift (seat height: 385-520 mm)

Item no	Base model +	Price Group (PG)	①	②	③	④	⑤	⑥	⑦	Price
9073	HÅG Tribute 9073 • Fully upholstered back • Extra comfort layer gives a more loose upholstery		8 533	8 716	9 022	9 381	9 730	11 187	13 089	

Accessories/Options/Surcharges:

HÅG Executive Basic armrests (with height and width adjustment)	1 759
All polished aluminium - only in combination with polished base FB020/FB039	1 336
Mix of black foot base and details in polished aluminium	324
Mix of polished foot base and details in black painted aluminium - only in combination with polished base FB020/FB039	1 128
Five star base (Ø650 mm) in polished aluminium	829
Four star base (Ø785 mm) in painted aluminium	- 359
Four star base (Ø785 mm) in polished aluminium	365
Universal castors Ø65 mm, for hard and soft floors, black	82

NB: PRICES MAY VARY WHEN OPTIONS ARE PURCHASED SEPARATELY FROM COMPLETE CHAIRS

HÅG® Excellence - task chair

- HÅG inBalance® (balanced, flowing tilt function backwards and forwards)
- Adjustable forwards and backwards tilt resistance
- Seat height adjustment
- Seat depth adjustment
- Adjustable lumbar support on all models
- Tilt lockable in three positions
- HÅG TiltDown™ armrests (tilt down, height and width) with black leather top
- Five star base (Ø740 mm) with sloping footplates, in matt black aluminium
- All aluminium components are standard black. Optionally 3 combinations are available. Please see specifications at previous HÅG executive collection pages and please specify colour at time for order.
- 150 mm lift (seat height: 387-525 mm)

Item no	Base model +	Price Group (PG)	⑥	⑦	Price
9321	HÅG Excellence 9321 <ul style="list-style-type: none"> • Rear of backrest is upholstered in black Plaintech • Seat and back available in Paloma Soft (PG 6) or Elmosoft (PG 7) 		24 032	28 117	
9331	HÅG Excellence 9331 <ul style="list-style-type: none"> • Adjustable headrest • Rear of backrest is upholstered in black Plaintech • Seat and back available in Paloma Soft (PG 6) or Elmosoft (PG 7) 		28 801	33 697	
Accessories/Options/Surcharges:					
	200 mm lift				180
	Without armrests				- 3 665
	HÅG Executive Basic armrests (with height and width adjustment)				- 1 919
	All polished aluminium - only in combination with polished base FB018				1 336
	Mix of black foot base and details in polished aluminium				324
	Mix of polished foot base and details in black painted aluminium - only in combination with polished base FB018				1 128
	Five star base (Ø740 mm), in polished aluminium				828
	Universal castors Ø65 mm, for hard and soft floors, black				82

NB: PRICES MAY VARY WHEN OPTIONS ARE PURCHASED SEPARATELY FROM COMPLETE CHAIRS

HÅG® Excellence - meeting chair

- HÅG inBalance® (balanced, flowing tilt function backwards and forwards)
- Seat height adjustment
- Adjustable back cushion (lumbar)
- Swivel
- Adjustable tilting resistance backwards
- Five star base (Ø650 mm) with sloping footplates, in matt black aluminium
- All aluminium components are standard black. Optionally 3 combinations are available. Please see specifications at previous HÅG executive collection pages and please specify colour at time for order.
- 150 mm lift (seat height: 385-520 mm)

Item no	Base model +	Price Group (PG)	⑥	⑦	Price
9373	HÅG Excellence 9373 <ul style="list-style-type: none"> • Rear of backrest is upholstered in black Plaintech • Seat and back available in Paloma Soft (PG 6) or Elmosoft (PG 7) 		16076	18809	



Accessories/Options/Surcharges:

HÅG Executive Basic armrests (with height and width adjustment)	1 759
All polished aluminium - only in combination with polished base FB020/FB039	1 336
Mix of black foot base and details in polished aluminium	324
Mix of polished foot base and details in black painted aluminium - only in combination with polished base FB020/FB039	1 128
Five star base (Ø650 mm) in polished aluminium	829
Four star base (Ø785 mm) in painted aluminium	- 359
Four star base (Ø785 mm) in polished aluminium	365
Universal castors Ø65 mm, for hard and soft floors, black	82

NB: PRICES MAY VARY WHEN OPTIONS ARE PURCHASED SEPARATELY FROM COMPLETE CHAIRS

HÅG® Inspiration - task chair

- HÅG inBalance® (balanced, flowing tilt function backwards and forwards)
- Adjustable forwards and backwards tilt resistance
- Seat height adjustment
- Seat depth adjustment
- Adjustable lumbar support on all models
- Tilt lockable in three positions
- HÅG TiltDown™ armrests (tilt down, height and width) with black leather top
- Five star base (Ø740 mm) with sloping footplates, in matt black aluminium
- All aluminium components are standard black. Optionally 3 combinations are available. Please see specifications at previous HÅG executive collection pages and please specify colour at time for order.
- 150 mm lift (seat height: 387-525 mm)

Item no	Base model +	Price Group (PG)	③	⑥	⑦	Price
9221	HÅG Inspiration 9221 <ul style="list-style-type: none"> • Back in Space (dark) • Seat and cushion available in Note (PG 3), Paloma Soft (PG 6) or Elmosoft (PG 7) 		14 497	16 251	19 013	
9231	HÅG Inspiration 9231 <ul style="list-style-type: none"> • Adjustable headrest • Back in Space (dark) • Seat and cushion available in Note (PG 3), Paloma Soft (PG 6) or Elmosoft (PG 7) 		17 086	22 082	25 837	
Accessories/Options/Surcharges:						
	200 mm lift					180
	Without armrests					- 1 919
	HÅG Executive Basic armrests (with height and width adjustment)					- 1 919
	All polished aluminium - only in combination with polished base FB018					1 336
	Mix of black foot base and details in polished aluminium					324
	Mix of polished foot base and details in black painted aluminium - only in combination with polished base FB018					1 128
	Five star base (Ø740 mm), in polished aluminium					828
	Universal castors Ø65 mm, for hard and soft floors, black					82

NB: PRICES MAY VARY WHEN OPTIONS ARE PURCHASED SEPARATELY FROM COMPLETE CHAIRS

HÅG® Inspiration - meeting chair

- HÅG inBalance® (balanced, flowing tilt function backwards and forwards)
- Seat height adjustment
- Adjustable back cushion (lumbar)
- Swivel
- Adjustable tilting resistance backwards
- Five star base (Ø650 mm) with sloping footplates, in matt black aluminium
- All aluminium components are standard black. Optionally 3 combinations are available. Please see specifications at previous HÅG executive collection pages and please specify colour at time for order.
- 150 mm lift (seat height: 385-520 mm)

Item no	Base model +	Price Group (PG)	③	⑥	⑦	Price
9273	HÅG Inspiration 9273 <ul style="list-style-type: none"> • Back in Space (dark). • Seat and cushion available in Note (PG 3), Paloma Soft (PG 6) or Elmosoft (PG 7) 		10 741	12 612	14 757	





Accessories/Options/Surcharges:

HÅG Executive Basic armrests (with height and width adjustment)	1 759
All polished aluminium - only in combination with polished base FB020/FB039	1 336
Mix of black foot base and details in polished aluminium	324
Mix of polished foot base and details in black painted aluminium - only in combination with polished base FB020/FB039	1 128
Five star base (Ø650 mm) in polished aluminium	829
Four star base (Ø785 mm) in painted aluminium	- 359
Four star base (Ø785 mm) in polished aluminium	365
Universal castors Ø65 mm, for hard and soft floors, black	82

NB: PRICES MAY VARY WHEN OPTIONS ARE PURCHASED SEPARATELY FROM COMPLETE CHAIRS

HÅG Creed® - task chair

- HÅG inBalance® (balanced, flowing tilt function backwards and forwards)
- 4 in 1 adjustment: Seat depth, back height and forward and backward tilt tension in one wheel
- Adjustable seat height
- Possibility to adjust backrest separately
- Lockable in three positions
- Five star base (Ø730 mm) in aluminium with curved/arched footplates, standard in black or silver, optionally in polished aluminium.
- Please specify colour at time of order
- 150 mm lift (Seat height: 390-515 mm)

Item no	Base model +	Price Group (PG)	①	②	③	④	⑤	⑥	⑦	Price
6002	HÅG Creed 6002 <ul style="list-style-type: none"> • Fully upholstered back • Low back • Available as electrostatic discharged (ESD) chair (PG 6 +10%). Headrest and armrests are not available for ESD chair 		7 112	7 351	7 549	8 184	8 458	9 871	11 548	
6003	HÅG Creed 6003 <ul style="list-style-type: none"> • Partially upholstered back • Medium back 		7 666	7 823	7 990	8 584	8 845	10 170	11 899	
6004	HÅG Creed 6004 <ul style="list-style-type: none"> • Fully upholstered back • Medium back • Available as electrostatic discharged (ESD) chair (PG 6 +10%). Headrest and armrests are not available for ESD chair 		7 894	8 262	8 458	9 140	9 411	10 989	12 856	
6005	HÅG Creed 6005 <ul style="list-style-type: none"> • Partially upholstered back • High back 		8 075	8 239	8 406	9 011	9 261	10 626	12 432	
6006	HÅG Creed 6006 <ul style="list-style-type: none"> • Fully upholstered back • High back 		8 283	8 698	8 856	9 554	9 843	11 584	13 552	

Accessories/Options/Surcharges:



	Headrest HÅG Creed	1 942	2 332	2 580	2 974	3 395	4 395	5 142
	200 mm lift							17
	265 mm lift (glides are recommended, no additional charge)							112
	Adjustable armrest							1 198
	- Surcharge for armrests with 3D-top							852
	- Surcharge for HÅG SwingBack® armrests							967
	Five star base (Ø730 mm) in polished aluminium							823
	Universal castors Ø65 mm, for hard and soft floors, black							82
169121	HÅG FootRing ¹							1 095
165177-1A/2A	HÅG StepUp 1 pcs							1 392
165134	HÅG Quickstep, 1 pcs							992

NB: PRICES MAY VARY WHEN OPTIONS ARE PURCHASED SEPARATELY FROM COMPLETE CHAIRS

[1] HÅG FootRing must be ordered together with 200 or 265 mm lift

HÅG Creed® - communication chair



- HÅG inBalance® (balanced, flowing tilt function backwards and forwards)
- Glides for hard or soft flooring need to be specified at time of order

Item no	Base model +	Price Group (PG)	Price Group							Price
			①	②	③	④	⑤	⑥	⑦	
6071	HÅG Creed 6071 • Sledge base in steel: Black or silver • Seat height: 445 mm		4 354	4 444	4 576	4 756	4 933	5 689	6 656	
6072	HÅG Creed 6072 • Adjustable seat height • Aluminium 5 star base (Ø730 mm) w/footplates: Black or silver • 150 mm lift (Seat height: 375-515 mm)		4 399	4 490	4 623	4 803	4 983	5 745	6 722	
Accessories/Options/Surcharges:										
Armrests in aluminium. Silver or black									967	
Five star base (Ø730 mm) in polished aluminium									823	
Universal castors Ø65 mm, for hard and soft floors, black									82	

NB: PRICES MAY VARY WHEN OPTIONS ARE PURCHASED SEPARATELY FROM COMPLETE CHAIRS

HÅG H03® - task chair

- HÅG inBalance® (balanced, flowing tilt function backwards and forwards)
- Seat height adjustment
- Combined adjustment of back height and seat depth
- Five star base (Ø686 mm) in plastic with sloping footplates
- 150 mm lift (seat height: 412-551 mm)

Item no	Base model +	Price Group (PG)	①	②	③	④	⑤	⑥	⑦	Price
330	HÅG H03 330 <ul style="list-style-type: none"> • Low back • Removable upholstery on seat and back • Back bar and arm slides in aluminium: Black or silver 		4974	5092	5418	5696	6040	6639	7768	
340	HÅG H03 340 <ul style="list-style-type: none"> • Medium back • Removable upholstery on seat and back • Back bar and arm slides in aluminium: Black or silver • Individual tilt tension adjustment 		5535	5649	5982	6271	6766	7098	8304	
350	HÅG H03 350 <ul style="list-style-type: none"> • Medium back • Fully upholstered seat and back • Back bar and arm slides in aluminium: Black or silver • Individual tilt tension adjustment 		6369	6500	6832	7275	7634	8525	9974	
Accessories/Options/Surcharges:										
	200 mm lift									16
	265 mm lift (glides are recommended, no additional charge) ¹									115
	Telescopic lift cover (200mm & 265mm)									90
	Adjustable armrests									697
	Five star base (Ø730 mm) in aluminium - silver/black									788
	Five star base (Ø730 mm) in polished aluminium									1133
	Universal castors Ø65 mm, for hard and soft floors, black									82
169121	HÅG FootRing ²									1095

NB: PRICES MAY VARY WHEN OPTIONS ARE PURCHASED SEPARATELY FROM COMPLETE CHAIRS

[1] 265 mm lift must be ordered together with five star base in aluminium

[2] Must be ordered together with 200 or 265 mm lift

HÅG® Celi - conference chair

- HÅG inBalance® (balanced, flowing tilt function backwards and forwards)
- 4 legs and back stems in aluminium. Available in four colours: Black, Blueberry, Blush Rose and Silver. Raw finish also available: due to the production process, lines, scratches and colour changes are natural part of this finish
- Seat and backrest in post-consumer PP or Natural Ash wooden veneer. PP available in 4 colours: Black, Crowberry, Chestnut and Slate. PP colour tones might vary due to use of recycled material
- Please specify colour at time of order
- Seat height: 440 mm
- Stackable: 12-15 chairs
- Hard glides for soft flooring is standard. Felt glides for hard flooring is optional and need to be specified at time of order - see accessories. Glides follow colour of the chair legs

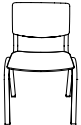
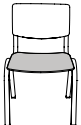
Item no	Base model +	Price Group (PG)	Price
9100	HÅG Celi 9100 • Plastic seat and back		2 104
9140	HÅG Celi 9140 • CeliKnit removable upholstery on seat • Plastic back		2 980
9160	HÅG Celi 9160 • CeliKnit removable upholstery on seat and back		3 307
9200	HÅG Celi 9200 • Wooden veneer seat and back		2 614
Accessories/Options/Surcharges:			
	Armrests in aluminium. Colour follows chair legs: Black, Blueberry, Blush Rose, Silver and Raw*		323
	Felt glides for hard flooring (4 units)		48
	Connection device HÅG Celi - cannot be combined with armrests		92
	Table hanger HÅG Celi		150
149285	Chair trolley		2 566

NB: PRICES MAY VARY WHEN OPTIONS ARE PURCHASED SEPARATELY FROM COMPLETE CHAIRS

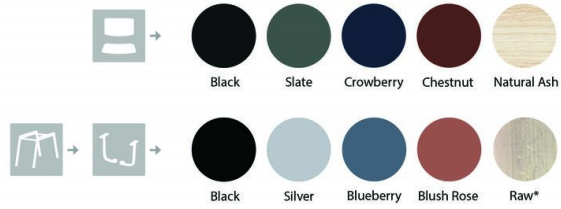

*) Raw finish: due to the production process, lines, scratches and colour changes are natural part of this finish. Raw armrests expected ready in December

CeliKnit - a 3D shape-knitted upholstery in recycled polyester offered in six colours:









S=Standard Collection - normal delivery time from factory 10-15 working days.
 E=Extended Collection - extended delivery time from factory 25-30 working days.
 For larger orders, please contact Customer Service for delivery details.

HÅG Conventio® - conference chair

- HÅG inBalance® (balanced, flowing tilt function backwards and forwards)
- Black or silver coloured back stems, must be specified at time of order for models 9512 and 9522

The following applies for models 9510, 9511, 9520 and 9521:

- Legs in black or silver aluminium. Please specify colour at time of order
- Stackable (15 chairs), only available for 4 legged models
- Glides for hard or soft flooring need to be specified at time of order

Item no	Base model +	Price Group (PG)	①	②	③	④	⑤	⑥	⑦	Price
9510	HÅG Conventio 9510 <ul style="list-style-type: none"> • Upholstered seat and backrest front (plastic back) • Removable upholstery • Built-in handle for carrying • Seat height: 455 mm 		2889	2947	3035	3154	3272	3771	4413	
9511	HÅG Conventio 9511 <ul style="list-style-type: none"> • Upholstered seat and backrest front (plastic back) • Removable upholstery • Built-in handle for carrying • 4 cm wider than 9510 • Seat height: 450 mm 		3189	3254	3350	3483	3612	4166	4875	
9512	HÅG Conventio 9512 <ul style="list-style-type: none"> • 5 star plastic foot base (Ø635 mm): Black • 150 mm lift • Seat height: 400-540 mm • Backstems in black or silver 		3603	3677	3790	3936	4083	4708	5507	
9520	HÅG Conventio 9520 <ul style="list-style-type: none"> • Upholstered seat and back • Removable upholstery • Seat height: 455 mm 		3068	3129	3221	3347	3474	4007	4687	
9521	HÅG Conventio 9521 <ul style="list-style-type: none"> • Upholstered seat and back • Removable upholstery • 4 cm wider than 9520 • Seat height: 450 mm 		3408	3478	3582	3722	3860	4453	5210	
9522	HÅG Conventio 9522 <ul style="list-style-type: none"> • 5 star plastic foot base (Ø635 mm): Black • 150 mm lift • Seat height: 400-540 mm • Backstems in black or silver 		3941	4023	4145	4306	4467	5149	6025	

Accessories/Options/Surcharges:

	Armrests in plastic	445
	HÅG Writing tablet. Black, right-handed. Fold down tablet for storage and stacking of chair. (Only for: 9510, 9511, 9520, 9521)	692
	HÅG Writing tablet. Black, right-handed + Armrest in plastic, left side. (Only for: 9510, 9511, 9520, 9521)	919
	Five star base (Ø730 mm) in aluminium - silver/black (Only for: 9512, 9522)	213
	Five star base (Ø730 mm) in polished aluminium (Only for: 9512, 9522)	1 224
	Universal castors Ø65 mm, for hard and soft floors, black (Only for: 9512, 9522)	89
	Chair hanger. Must be specified at time of order. Can not be retrofitted (Only for: 9512, 9522)	502
	Chair hanger. Must be specified at time of order. Can not be retrofitted (Only for: 9510, 9511, 9520, 9521)	502
	Connection device - only available for 4 legged models without arms (Only for: 9510, 9511, 9520, 9521)	94
	Connection device - only available for 4 legged models with arms (Only for: 9510, 9511, 9520, 9521)	94
	HÅG SlipCover available in Atlantic (Gabriel) off-white or grey (Only for: 9510, 9520)	836
149285	Chair trolley	2 566

NB: PRICES MAY VARY WHEN OPTIONS ARE PURCHASED SEPARATELY FROM COMPLETE CHAIRS



108984

HÅG Conventio Wing® - conference chair

- HÅG inBalance® (balanced, flowing tilt function backwards and forwards)
- Models 9811, 9821, 9831: 4 legs and backstems in matt black or silver coloured aluminium
- Please specify colour at time of order
- Models 9812, 9822, 9832: 5 star foot base in black plastic. 150 mm gas lift.
- Seat and backrest available in 5 different colours: Clay, Sea Green, Black, White and Red
- Stackable: 15 chairs (4 legged models)
- Glides for hard or soft flooring need to be specified at time of order

Item no	Base model +	Price Group (PG)	①	②	③	④	⑤	Price
9811	HÅG Conventio Wing 9811 • Plastic seat and back • Seat height: 430 mm							2 205
9812	HÅG Conventio Wing 9812 • Plastic seat and back • 5 star plastic foot base (Ø635 mm) • Seat height: 375-515 mm							2 846
9821	HÅG Conventio Wing 9821 • Removable upholstery on seat • Plastic back • Seat height: 430 mm		2 549	2 601	2 864	3 129	3 230	
9822	HÅG Conventio Wing 9822 • Removable upholstery on seat • Plastic back • 5 star plastic foot base (Ø635 mm) • Seat height: 380-520 mm		3 130	3 195	3 528	3 808	3 988	
9831	HÅG Conventio Wing 9831 • Removable upholstery on seat and back • Seat height: 430 mm		2 993	3 053	3 372	3 650	3 793	
9832	HÅG Conventio Wing 9832 • Removable upholstery on seat and back • 5 star plastic foot base (Ø635 mm) • Seat height: 380-520 mm		3 577	3 650	4 023	4 355	4 558	



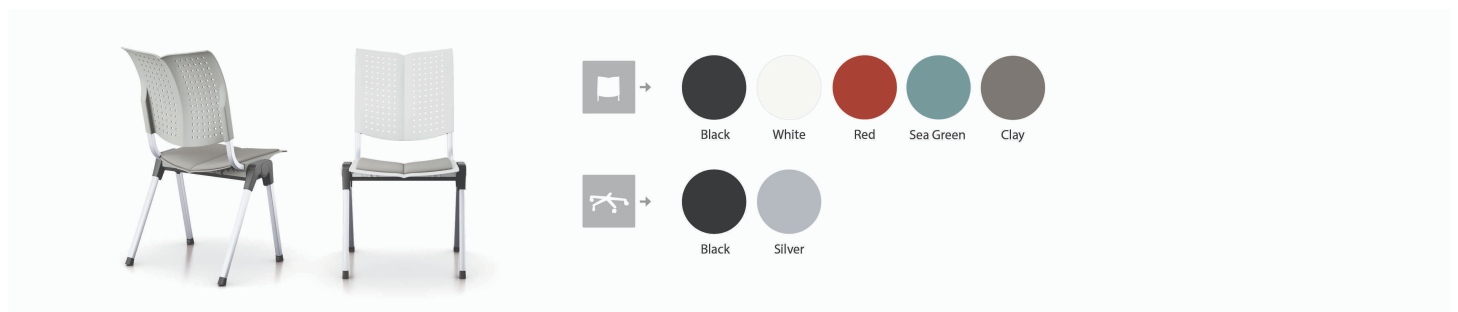

Accessories/Options/Surcharges:

	Armrests in plastic	445
	HÅG Writing tablet. Black, right-handed. Fold down tablet for storage and stacking of chair. (Only for: 9811, 9821, 9831)	692
	HÅG Writing tablet. Black, right-handed + Armrest in plastic, left side. (Only for: 9811, 9821, 9831)	919
165243-1A	Chair suspension for mounting under table top. Black	242
165243-2A	Chair suspension for mounting under table top. Silver	242
	Chair hanger. Must be specified at time of order. Can not be retrofitted (Only for: 9812, 9822, 9832)	502
	Chair hanger. Must be specified at time of order. Can not be retrofitted (Only for: 9811, 9821, 9831)	502
	Connection device - only available for 4 legged models without arms (Only for: 9811, 9821, 9831)	94
	Connection device - only available for 4 legged models with arms (Only for: 9811, 9821, 9831)	94
	Five star base (Ø730 mm) in aluminium - silver/black (Only for: 9812, 9822, 9832)	213
	Five star base (Ø730 mm) in polished aluminium (Only for: 9812, 9822, 9832)	1 224
	Universal castors Ø65 mm, for hard and soft floors, black (Only for: 9812, 9822, 9832)	89
149285	Chair trolley	2 566

NB: PRICES MAY VARY WHEN OPTIONS ARE PURCHASED SEPARATELY FROM COMPLETE CHAIRS

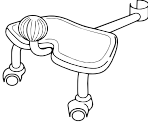

HÅG Accessories

Item no	Base model +	Price Group (PG)	Price
165177-1A/2A	<p>HÅG StepUp 1 pcs</p> <ul style="list-style-type: none"> • Provides two extra levels for your feet • Greater variety of seating positions • Black (1A) or silver (2A) • Easy to attach and detach • For use with 150, 200 and 265 mm gas lifts • Suits desk heights of 80-95 cm • Add on: Universal castor, Ø65 mm, black (Must be specified at time of order) 		1392
165178-1A/2A	<p>HÅG StepUp</p> <ul style="list-style-type: none"> • As art. 165177, but two pack • Black (1A) or silver (2A) 		2780
165134	<p>HÅG Quickstep, 1 pcs</p> <ul style="list-style-type: none"> • Tilting footrest, stimulates circulation • Foot massager • Balance training 		992
165129	<p>HÅG QuickStep</p> <ul style="list-style-type: none"> • Six pack 		4961
169121	<p>HÅG FootRing</p> <ul style="list-style-type: none"> • Available colours (aluminium ring) / (plastic busher): Black/black (1A), White/black (3A), Silver/grey (2D), White/grey (3D) • Additional height for the feet to rest on • Compatible with all HÅG task chairs (except HÅG Executive) with 200 or 265 mm gas lifts 		1095
149285	<p>Chair trolley</p> <ul style="list-style-type: none"> • For HÅG Conventio and HÅG Conventio Wing with 4 legs only • Recommended for max 8 pcs • Silver 		2566

Main Spare Parts

Explanation to colour codes:

No colour code specified = Semi matt polyester paint on metal components, or single black plastic parts

1 = Semi matt black polyester paint on metal components

2 = Fine structured silver polyester paint on metal components

3 = Semi matt white polyester paint on metal components

P = Polished metal

P1 = Polished metal and semi matt black polyester painted metal components

1A = Semi matt black polyester paint on metal components and black plastic parts

2A = Fine structured silver polyester paint on metal components and black plastic parts

2D = Fine structured silver polyester paint on metal components and grey plastic parts

3A = Semi matt white polyester paint on metal components and black plastic parts

3D = Semi matt white polyester paint on metal components and grey plastic parts

PA = Polished metal components and black plastic parts

BB = Glossy black polyester paint on metal components and black plastic parts

NB = Anodised metal components (aluminium colour) and black plastic parts

Item no	Gas lifts	Price
143200-1A	A, 150 mm, black	972
143200-2A	A, 150 mm, silver	972
143200-3	A, 150 mm, white for HÅG Tion, HÅG Capisco and HÅG Capisco Puls	972
143202-1A	D, 200 mm, black	1065
143202-2A	D, 200 mm, silver	1065
143202-3	D, 200 mm, white for HÅG Tion, HÅG Capisco and HÅG Capisco Puls	1065
143204-1A	E, 265 mm, black	1137
143204-2A	E, 265 mm, silver	1137
143204-3	E, 265 mm white, for HÅG Capisco and HÅG Capisco Puls	1137
143211-1A	165 mm gaslift, black for HÅG SoFi/HÅG Futu	1000
143211-2A	165 mm, silver, for HÅG SoFi/HÅG Futu	1000
143211-3A	165 mm, white for HÅG SoFi	1000
143218-1A	200 mm, black for HÅG SoFi/HÅG Futu	1109
143218-2A	200 mm, silver for HÅG SoFi/HÅG Futu	1109
143218-3A	200 mm, white for HÅG SoFi	1109
143173-1A	200 mm, with black lift cover for HÅG Executive models	1181
143173-PA	200 mm, with polished lift cover for HÅG Executive models	1181
143172-1A	150 mm, with black lift cover for HÅG Executive models	634
143172-PA	150 mm, with polished lift cover for HÅG Executive models	634
143212-1A	150 mm, with black lift cover for HÅG Executive meeting models	634
143212-PA	150 mm, with polished lift cover for HÅG Executive meeting models	634
143206-1A	150 mm, black, for HÅG H03, HÅG Conventio, HÅG Conventio Wing	733
143200-5	A, 150 mm, Blush Rose for HÅG Tion	972
143200-7	A, 150 mm, Moss Grey for HÅG Tion	972
143202-5	D, 200 mm, Blush Rose for HÅG Tion	1065
143202-7	D, 200 mm, Moss Grey for HÅG Tion	1065

Item no	Footbases, excluding castors	Price
126158	Five star foot base for HÅG Executive models in matt black aluminium	1 408
126154-P	Five star foot base for HÅG Executive models in polished aluminium	2 259
126178	Five star foot base for HÅG Executive meeting in matt black aluminium	1 111
126160-P	Five star foot base for HÅG Executive meeting in polished aluminium	2 174
113162	Five star foot base for HÅG Conventio 9512, 9522, HÅG Conventio Wing 9812, 9822, 9832 in black plastic	502
113163	Five star foot base for HÅG H03 in black plastic	502
113940	Five star foot base for HÅG Futu in black plastic	502
113016	Five star foot base for HÅG Capisco Puls, in black plastic	641
126172-2	Five star foot base for HÅG Creed/Capisco/Capisco Puls in silver aluminium	937
126172-1	Five star foot base for HÅG Creed/Capisco/Capisco Puls in black aluminium	937
126172-3	Five star foot base for HÅG Capisco/Capisco Puls in white aluminium	937
126172-P	Five star foot base for HÅG Creed/Capisco/Capisco Puls in polished aluminium	1 772
126164-2A	Four star foot base for HÅG SoFi Comm., in silver aluminium, w/hard glides for soft floor	987
126164-1A	Four star foot base for HÅG Executive meeting/SoFi Comm., in black alum. w/hard glides for soft floor	987
126164-3A	Four star foot base for HÅG SoFi Comm., in white aluminium, w/hard glides for soft floor	987
126164-PA	Four star foot base for HÅG Executive meeting/SoFi Comm., in polished alum. w/hard glides for soft floor	1 710
126165-2A	Four star foot base for HÅG SoFi Comm., in silver aluminium, w/soft glides for hard floor	987
126165-1A	Four star foot base for HÅG Executive meeting/SoFi Comm., black alum. w/soft glides for hard floors	987
126165-3A	Four star foot base for HÅG SoFi Comm., in white aluminium, w/soft glides for hard floor	987
126165-PA	Four star foot base for HÅG Executive meeting/SoFi Comm., in polished alum w/soft glides for hard floor	1 710
126176-2	Five star foot base for HÅG SoFi/Futu/SoFi Comm. in silver aluminium	862
126176-1	Five star foot base for HÅG SoFi/Futu/SoFi Comm. in black aluminium	862
126176-3	Five star foot base for HÅG SoFi/SoFi Comm. in white aluminium	862
126173-P	Five star foot base for HÅG SoFi/Futu/SoFi Comm. in polished aluminium	1 583
126185-1	Five star foot base for HÅG Tion in Black painted aluminium	617
126185-2	Five star foot base for HÅG Tion in Silver painted aluminium	617
126185-3	Five star foot base for HÅG Tion in White painted aluminium	617
126185-7	Five star foot base for HÅG Tion in Moss Grey painted aluminium	617
126185-5	Five star foot base for HÅG Tion in Blush Rose painted aluminium	617
126184-P	Five star foot base for HÅG Tion in Polished aluminium	1 086
126184-9	Five star foot base for HÅG Tion in Tumbled aluminium	820

Item no	Universal castors for soft floor/carpets and for hard floors (price per castor)	Price
125177	Castors Ø65 mm, for hard and soft floors, black	88
125177-D	Castors Ø65 mm, for hard and soft floors, grey	88
125189	Castors Ø65mm HÅG Tion, for hard and soft floors, black	88

Item no	Castors for hard floors (price per castor)	Price
125108	Castors Ø50 mm, for hard floors, black	88

Item no	Castors for soft floor / carpets (price per castor)	Price
125104	Castors for soft floors, Ø50 mm, black	88
125178	Castors for soft floors, Ø65 mm, black	88

Item no	Glides (price per glide)	Price
125182	Universal glides for foot bases (task chairs)	88
113846	Carpet glides HÅG Conventio and HÅG Conventio Wing	16
113927	Carpet glides HÅG executive meeting, HÅG SoFi Comm. and HÅG Futu Comm. with 4-star base	15

Item no	Felt glides for conference/visitor chairs (price per glide)	Price
125186	Felt glides HÅG Conventio and HÅG Conventio Wing	31
125172	Felt glides HÅG Creed 6071	15
125179	Felt glides (22 mm) for HÅG Executive meeting, HÅG SoFi Comm., HÅG Futu Comm. with 4-star base	15

Item no	Armrests HÅG SoFi	Price
133539-2D	Armrests HÅG SoFi, adj. in light grey plastic with soft tops and poles in silver painted aluminium	1 826
133539-1A	Armrests HÅG SoFi, adj. in black plastic with soft tops and poles in black painted aluminium	1 826
133539-3D	Armrests HÅG SoFi, adj. in light grey plastic with soft tops and poles in white painted aluminium	1 826
133539-PA	Armrests HÅG SoFi, adj. in black plastic with soft tops and poles in polished painted aluminium	3 227
133539-2	Armrests HÅG SoFi, adj. in silver painted alum. with soft tops	2 176
133539-1	Armrests HÅG SoFi, adj. in black painted alum. with soft tops	2 176
133539-3	Armrests HÅG SoFi, adj. in white painted alum. with soft tops	2 176
133539-P	Armrests HÅG SoFi, adj. in polished alum. with soft tops	3 577
	- Surcharge for HÅG SlideBack	386
	- Surcharge for 3D	416
	- Surcharge for leather top	716

Item no	Armrests HÅG Tion	Price
133575-1	Armrests HÅG Tion Black	732
133575-2	Armrests HÅG Tion Silver	732
133575-3	Armrests HÅG Tion White	732
133575-7	Armrests HÅG Tion Moss Grey	732
133575-5	Armrests HÅG Tion Blush Rose	732
133575-P	Armrests HÅG Tion Polished	1 248
133575-9	Armrests HÅG Tion Tumbled	1 043

Item no	Armrests HÅG Creed	Price
133299-1A	Armrests HÅG Creed, adjustable, black	1 303
133299-2A	Armrests HÅG Creed, adjustable, silver	1 303
133300-1A	Armrests HÅG Creed, adj., w HÅG SwingBack, black	2 271
133300-2A	Armrests HÅG Creed, adj., w HÅG SwingBack, silver	2 271
133333-1A	Armrests HÅG Creed Comm. 6071 & 6072 black	1 054
133333-2A	Armrests HÅG Creed Comm. 6071 & 6072 silver	1 054
AR217	- Surcharge for armrests with 3D-top	852

Item no	Armrests	Price
133448-BB	Armrests HÅG Executive, task and meeting, basic, black	1 913
133548-1A	Armrests HÅG Executive task, HÅG TiltDown, black	3 099
133548-PA	Armrests HÅG Executive task, HÅG TiltDown, polished	3 099
133453-2A	Armrests HÅG Futu, adjustable silver	1 091
133453-1A	Armrests HÅG Futu, adjustable black	1 091
133322	Armrests HÅG H03, adjustable black	756
165232	Armrests HÅG Conventio, HÅG Conventio Wing, black	448

Item no	Headrest complete	①	②	③	④	⑤	⑥	⑦
134188	Headrest HÅG SoFi 7200, 7300	2 030	2 074	2 147	2 231	2 316	2 661	3 114
134189	Headrest HÅG SoFi mesh 7500	2 030	2 074	2 147	2 231	2 316	2 661	3 114
134172	Headrest HÅG Capisco 8106, 8107, 8126, 8127	2 666	2 831	3 035	3 267	3 570	4 327	5 063
134191	Headrest HÅG Tribute 9031	2 984	3 049	3 155	3 281	3 403	3 914	4 579
134194	Headrest HÅG Creed	2 589	2 750	2 944	3 171	3 467	4 202	4 916

Item no	Coathanger	Price
165256	Coat hanger, light grey or black plastic, for HÅG SoFi 7500 Mesh only. Not applicable with headrest.	617
102340-B01	Coat hanger, black stained wood, for HÅG Excellence and HÅG Inspiration	Price on request
168403-1A	Coat hanger, black w/bushing, for HÅG Tribute 9031 with headrest	584
168403-PA	Coat hanger, polished w/bushing, for HÅG Tribute 9031 with headrest	710

Item no	Lumbar support	Price
213184	Lumbar support HÅG Futu mesh	360

Item no	Replaceable upholstery HÅG Executive	①	②	③	④	⑤	⑥	⑦
108781	Headrest HÅG Excellence and HÅG Inspiration 9231,9331			856		921	1063	1244
111546	Back, complete, HÅG Tribute 9021, 9073	8943	9126	9400	9764	10039	11133	13026
111547	Back, complete, HÅG Tribute 9031	9887	10091	10394	10797	11101	12310	14403
108853-ATG56100	Back, HÅG Excellence 9331 Paloma Soft						9860	
108852-ATG56100	Back, HÅG Excellence 9321 and 9373 Paloma Soft						9643	
108005	Seat cover HÅG Tribute	1021	1094	1248	1505	1722	1889	2210
108009	Seat, HÅG Excellence/Inspiration			1188		1639	1801	2107
146256	Seat, complete, HÅG Tribute	1722	1861	2148	2527	2939	3244	3795
146257	Seat, complete, HÅG Excellence/Inspiration			2047		2800	3089	3614
108779	Lumbar support HÅG Excellence and HÅG Inspiration			1336		1440	1662	1945
Item no	Replaceable upholstery HÅG SoFi	①	②	③	④	⑤	⑥	⑦
111533	Headrest upholstery HÅG SoFi complete	899	928	1032	1094	1335	1427	1669
108975	Back HÅG SoFi 7200 (medium)	964	996	1107	1173	1432	1532	1792
108974	Back HÅG SoFi 7300 (high)	1054	1090	1208	1280	1560	1672	1956
108976	Seat HÅG SoFi	1149	1189	1319	1400	1707	1825	2135
108001	Lumbar pillow front, HÅG SoFi 750x (mesh)	79	80	82	88	89	103	121
108002	Lumbar pillow rear, HÅG SoFi 750x (mesh)	79	80	82	88	89	103	121
Item no	Replaceable upholstery HÅG Capisco	①	②	③	④	⑤	⑥	⑦
108706	Headrest HÅG Capisco and HÅG Creed	622	635	668	682	713	782	915
108803	Back, HÅG Capisco all models	1307	1333	1678	2305	2439	2992	3501
108769	Seat, HÅG Capisco 8105, 8106, 8107	1210	1233	1464	1855	2085	2897	3390
108800	Seat, HÅG Capisco 8126, 8127	1232	1258	1448	1591	1985	2188	2560
Item no	Replaceable upholstery HÅG Capisco Puls	①	②	③	④	⑤	⑥	⑦
108037	Cushion, HÅG Capisco Puls, mod. 8002 and 8020 (visible seaming)	1198	1224	1266	1307	1356	1559	1824
108958	Pad, HÅG Capisco Puls, model 8001 and 8010	400	406	428	444	460	499	584
Item no	Replaceable upholstery HÅG Tion	①	②	③	④	⑤	⑥	⑦
108035	Seat cover HÅG Tion	996	1006	1045	1098	1164	1350	1580
108036	Back cover HÅG Tion	832	839	874	917	972	1127	1319

Item no	Replaceable upholstery HÅG Creed	①	②	③	④	⑤	⑥	⑦
108706	Headrest HÅG Capisco and HÅG Creed	622	635	668	682	713	782	915
108030	Back HÅG Creed 6002	1 109	1 422	1 464	1 517	1 579	1 721	2 013
108528	Back, HÅG Creed 6003 (and old HÅG H05 5300)	1 297	1 332	1 490	1 597	1 927	2 077	2 429
108031	Back HÅG Creed 6004	1 153	1 297	1 360	1 422	1 464	1 631	1 908
108529	Back, HÅG Creed 6005 (and old HÅG H05 5500)	1 309	1 349	1 502	1 618	1 950	2 099	2 455
108032	Back HÅG Creed 6006	1 280	1 297	1 360	1 422	1 464	1 631	1 908
108696	Back, HÅG Creed 6071 and 6072	1 251	1 280	1 360	1 406	1 452	1 618	1 894
108029	Seat HÅG Creed	886	901	931	960	996	1 109	1 297
108697	Seat, HÅG Creed 6071 and 6072	901	915	957	996	1 041	1 125	1 317

Item no	Replaceable uph. for the discontinued HÅG H05	①	②	③	④	⑤	⑥
108603	Headrest, HÅG H05 5200, 5400, 5600	1 081	1 113	1 240	1 333	1 611	1 731
108527	Back, HÅG H05 5100	1 297	1 333	1 489	1 598	1 933	2 085
108515	Back, HÅG H05 5200	1 163	1 188	1 327	1 436	1 587	1 719
108516	Back, HÅG H05 5400	1 197	1 222	1 359	1 466	1 620	1 750
108517	Back, HÅG H05 5600	1 229	1 253	1 394	1 500	1 650	1 783
108630	Back, HÅG H05 5370	1 111	1 141	1 272	1 374	1 654	1 779
108632	Back, HÅG H05 5470	913	942	1 051	1 128	1 366	1 473
108522	Seat, HÅG H05	1 090	1 119	1 250	1 343	1 620	1 746
108631	Seat, HÅG H05 5370, 5470	828	851	952	1 019	1 233	1 327

Item no	Replaceable uph. for the discontinued HÅG H04	①	②	③	④	⑤	⑥
108692	Back, HÅG H04 4100, 4200	1 141	1 158	1 204	1 250	1 304	1 464
108690	Back, HÅG H04 4400	1 188	1 204	1 250	1 319	1 380	1 508
108691	Back, HÅG H04 4600	1 319	1 333	1 402	1 464	1 508	1 678
108695	Back, HÅG H04 4650	1 419	1 464	1 508	1 563	1 627	1 771
108869	Seat, HÅG H04 4100	1 029	1 059	1 090	1 119	1 158	1 266
108870	Seat, HÅG H04 4200, 4400, 4600	913	926	958	988	1 029	1 141
108871	Seat, HÅG H04 4650	991	1 013	1 059	1 090	1 119	1 233

Item no	Replaceable upholstery HÅG H03	①	②	③	④	⑤	⑥	⑦
108620	Back, HÅG H03 330	1 037	1 059	1 091	1 133	1 175	1 355	1 586
108615	Back, HÅG H03 340	924	942	971	1 011	1 045	1 207	1 412
108673	Seat, HÅG H03 330, 340	1 037	1 059	1 091	1 133	1 175	1 355	1 586
108619	Seat, HÅG H03 350	1 149	1 174	1 208	1 255	1 302	1 501	1 756

Item no	Replaceable upholstery HÅG Conventio	①	②	③	④	⑤	⑥	⑦
108728	Back, HÅG Conventio 9510	924	942	971	1011	1045	1207	1412
108730	Back, HÅG Conventio 9511, 9512	924	942	971	1011	1045	1207	1412
108391	Back, HÅG Conventio 9520	955	973	1002	1041	1080	1247	1459
108534	Back, HÅG Conventio 9521, 9522	955	973	1002	1041	1080	1247	1459
108729	Seat, HÅG Conventio 9510	924	942	971	1011	1045	1207	1412
108731	Seat, HÅG Conventio 9511, 9512	924	942	971	1011	1045	1207	1412
108946	Seat, HÅG Conventio 9520	955	973	1002	1041	1080	1247	1459
108535	Seat, HÅG Conventio 9521, 9522	955	973	1002	1041	1080	1247	1459

Item no	Replaceable upholstery HÅG Conventio Wing	①	②	③	④	⑤
108872	Back, HÅG Conventio Wing 9831, 9832	737	752	775	804	836
108873	Seat, HÅG Conventio Wing 9821, 9822, 9831, 9832	699	713	733	763	791

Item no	Miscellaneous	Price
149146	Disassembly tool for gas lift	619
149203	Disassembly tool for diverse (for removing back of HÅG Creed and the seats of HÅG Creed/Capisco)	173

Removable upholsteries are available for all HÅG chairs. Please contact Customer Service for support.

Physical Measurements - HÅG task and meeting chairs

HÅG office (task) chairs are tested in accordance with EN 1335-1.

EN 1335 is an European Standard for office chairs and considers dimensions of the chair, safety requirements and safety test methods. The European Standard tests are based on 8 hours daily use by persons weighing up to 110 kg (17.3 stone).

HÅG meeting chairs are tested in accordance with EN 16139 and has fewer measurements given compared to EN 1335.

EN 16139 is an European Standard that specifies requirements for the safety, strength and durability of all types of non-domestic seating.

TABLE OVERVIEW:

HÅG SoFi and HÅG Capisco

HÅG Capisco Puls, HÅG Futu and HÅG H03

HÅG Tion and HÅG Creed

HÅG executive collection

- HÅG Tribute
- HÅG Inspiration
- HÅG Excellence

MEASURE POINT REFERENCES:

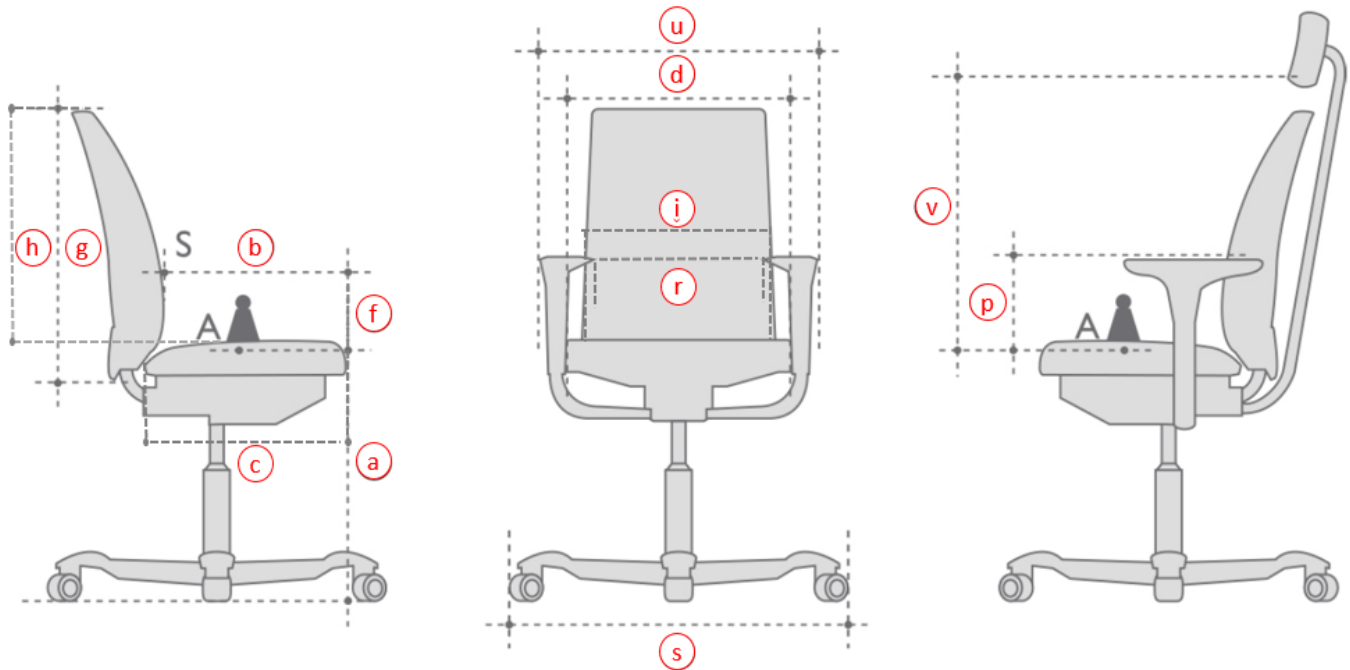

		HÅG SoFi						HÅG Capisco				
Models:		task			meeting			HÅG Capisco 8105	HÅG Capisco 8106	HÅG Capisco 8107	HÅG Capisco 8126	HÅG Capisco 8127
		HÅG SoFi 7200	HÅG SoFi 7300	HÅG SoFi mesh 7500	HÅG SoFi comm 7202	HÅG SoFi comm 7302	HÅG SoFi mesh comm 7502					
All measurements in mm. Few exceptions are specified.												
Seat height, measured with 64 kg load	165 mm lift (a)	393-541	393-541	397-546	393-541	393-541	397-546					
	150 mm lift* (a)							380-515	417-547	417-547	417-547	417-547
	200 mm lift (a)	450-640	450-640	450-640				445-630	470-655	470-655	470-655	470-655
	265 mm lift (a)							530-790	555-810	555-810	555-810	555-810
Seat depth with slide (b)		386-460	386-460	393-465	386-460	386-460	393-465		335-390	335-390	335-390	335-390
Seat depth (c)		443	443	446	443	443	446					
Seat width (d)		451	451	448	451	451	448	470	470	470	470	470
Height of the back supporting point (S) above the seat (f)		167-228	167-228	167-234	167-228	167-228	167-234		105-195	105-195	105-195	105-195
Backrest height (g)		608	708	725	708	708	725		460	460	460	460
Backrest height adjustment (h)									390-480	390-480	390-480	390-480
Backrest width (i)		442	442	467	442	442	467					
Back rest inclination (deg)		31.5	31.5	30	24	24	24		16.8	16.8	16.8	16.8
Armrest height (p)		195-307	195-307	188-299	195-307	195-307	188-299					
Headrest height (v)		630-835	630-835	630-835						555-785		0-785
Distance between armrests (r)		385-520	385-520	416-554	385-520	385-520	416-554					
Chair width (u)		600-715	600-715	600-715	600-715	600-715	600-715		595	595	595	595
Neutral position (deg)		- 4	- 4	- 4	- 2	- 2	- 2		2	2	2	2
Tilt range (deg)**		(12.9) - (-17.4)	(12.9) - (-17.4)	(13) - (-17)	(11) - (-13)	(11) - (-13)	(11) - (-13)		(2) - (-15)	(2) - (-15)	(2) - (-15)	(2) - (-15)
Foot base diameter (s)		730	730	730	785	785	785	730	730	730	730	730
Chair weight (kg)		17.3	17.5	17	16.2	16.7	15.7	7.5	14	15.5	14.5	15.5

* According to EN1335 Class A ** Tilt range degrees (forwards) - (backwards)
Please note that these measurements are not absolute. They may vary slightly from chair to chair.

		HÅG Capisco Puls				HÅG Futu			HÅG H03		
Models:		HÅG Capisco Puls 8001	HÅG Capisco Puls 8002	HÅG Capisco Puls 8010	HÅG Capisco Puls 8020	task		meeting	HÅG H03 330	HÅG H03 340	HÅG H03 350
						HÅG Futu mesh 1100-S	HÅG Futu 1200-S	HÅG Futu mesh comm 1102-S			
All measurements in mm. Few exceptions are specified.											
Seat height, measured with 64 kg load	165 mm lift (a)					398-551	398-551	398-551			
	150 mm lift* (a)	365-500	375-515	392-525	392-525				412-551	412-551	412-551
	200 mm lift (a)	455-620	470-635	455-640	470-650	450-640	450-640		520-700	520-700	520-700
	265 mm lift (a)	540-770	555-785	540-795	555-805				548-783	548-783	548-783
Seat depth with slide (b)				399-439	399-439	390-470	385-460	390-470	400-425	400-425	400-425
Seat depth (c)		415	415	415	415	460	460	460	460	460	460
Seat width (d)		460	460	460	460	460	460	460	420	420	445
Height of the back supporting point (S) above the seat (f)				140-230	127-222	170-240	160-255		174-244	165-235	159-229
Backrest height (g)				399	399	600	600	600	300	410	425
Backrest height adjustment (h)				381-471	381-471				336-406	336-406	458-528
Backrest width (i)				470	470	370	554	370	400	400	410
Back rest inclination (deg)				17.8	17.8	27	27	27	21.4	21.4	21.4
Armrest height (p)						164-264	164-264	164-264	171-281	171-281	171-281
Headrest height (v)											
Distance between armrests (r)						444-554	444-554	444-554	458	458	458
Chair width (u)				565	565	610-715	610-715	610-715	630	630	630
Neutral position (deg)		- 3.8	- 3.8	- 3.8	- 3.8	- 4	- 4	- 4	0	0	0
Tilt range (deg)**				(3.8) - (-19.2)	(3.8) - (-19.2)	(10.6) - (-17.6)	(10.6) - (-17.6)	(10.6) - (-17.6)	(12) - (-10)	(12) - (-10)	(12) - (-10)
Foot base diameter (s)		730	730	730	730	730	730	785	686	686	686
Chair weight (kg)		7	7	11.1	11.1	16.2	15.3	16.2	12	12	13

* According to EN1335 Class A ** Tilt range degrees (forwards) - (backwards)
Please note that these measurements are not absolute. They may vary slightly from chair to chair.

		HÅG Tion					HÅG Creed						
Models:							task					meeting	
							HÅG Creed 6002	HÅG Creed 6003	HÅG Creed 6004	HÅG Creed 6005	HÅG Creed 6006	HÅG Creed comm 6071	HÅG Creed comm 6072
All measurements in mm. Few exceptions are specified.		HÅG Tion 2100	HÅG Tion 2140	HÅG Tion 2160	HÅG Tion 2200	HÅG Tion 2240	HÅG Creed 6002	HÅG Creed 6003	HÅG Creed 6004	HÅG Creed 6005	HÅG Creed 6006	HÅG Creed comm 6071	HÅG Creed comm 6072
Seat height, measured with 64 kg load	150 mm lift* (a)	408-542	408-542	408-542	408-542	408-542	397-537	400-510	400-510	400-510	395-535		395-535
	200 mm lift (a)	485-664	485-664	485-664	485-664	485-664	455-635	455-635	455-635	455-635	454-637		
Seat depth with slide (b)		425	435	435	422	435	390-490	400-420	390-490	400-420	390-490		
Seat depth (c)		425	435	435	422	435	425	425	430	425	425	430	430
Seat width (d)		455	470	470	450	470	455	455	445	455	450	445	445
Height of the back supporting point (S) above the seat (f)		240	240	240	240	240	170-226	170-226	170-228	170-226	170-239		
Backrest height (g)		251	251	257	253	253	455	475	510	555	585	510	510
Backrest height adjustment (h)							401-454	401-454	466-511	401-454	508-552		
Backrest width (i)		464	464	464	464	464	390	388	385	388	385	385	385
Back rest inclination (deg)		-5.7	-5.7	-5.7	-5.7	-5.7	20.3	20.3	19.1	20.3	20.4	22	22
Armrest height (p)		229	229	229	229	229	390-490	390-490	182-277	390-490	200-300		
Distance between armrests (r)		492	492	492	492	492	454-546		454-546		454-546		
Chair width (u)		600	600	600	600	600							
Neutral position (deg)		-3	-3	-3	-3	-3	-1	-1	-1	-1	-1	-5	-5
Tilt range (deg)		(7.4) - (-14)	(7.4) - (-14)	(7.4) - (-14)	(7.4) - (-14)	(7.4) - (-14)	(15) - (-16)	(15) - (-16)	(15) - (-16)	(15) - (-16)	(15) - (-16)	(9) - (-13)	(9) - (-13)
Foot base diameter (s)		620	620	620	620	620	730	730	730	730	730		730
Chair weight (kg)		10.9	10.9	11.1	13.7	13.2	13.3	15.7	17	18.6	19	10	9

* According to EN1335 Class A ** Tilt range degrees (forwards) - (backwards)

Please note that these measurements are not absolute. They may vary slightly from chair to chair.

		HÅG executive								
Model:		task					meeting			
		HÅG Tribute 9021	HÅG Tribute 9031 (headrest)	HÅG Inspiration 9221	HÅG Inspiration 9231	HÅG Excellence 9321	HÅG Excellence 9331	HÅG Tribute meeting 9073	HÅG Inspiration meeting 9273	HÅG Excellence meeting 9373
All measurements in mm. Few exceptions are specified.										
Seat height, measured with 64 kg load	150 mm lift* (a)	387-525	387-525	387-525	387-525	387-525	387-525	387-525	387-525	387-525
	200 mm lift (a)	460-640	460-640	460-640	460-640	460-640	460-640			
Seat depth with slide (b)		390-508	390-508	390-508	390-508	390-508	390-508			
Seat depth (c)		480	480	480	480	480	480	480	480	480
Seat width (d)		460	460	460	460	460	460	460	460	460
Height of the back supporting point (S) above the seat (f)		170-238	170-238	128-233	128-233	128-233	128-233	170-238	128-233	128-233
Backrest height (g)		740	740	923	1 203	923	1 203	740	923	923
Backrest height adjustment (h)										
Backrest width (i)		460	460	460	460	460	460	460	460	460
Back rest inclination (deg)		28.3	28.3	28.3	28.3	28.3	28.3	26	27	27
Armrest height (p)		200-300	200-300	200-300	200-300	200-300	200-300			
Headrest height (v)			680-795		660-770		660-770	680-795		
Distance between armrests (r)		458-536	458-536	458-536	458-536	458-536	458-536	458-536	458-536	458-536
Chair width (u)		495-675	495-675	495-675	495-675	495-675	495-675	495-675	495-675	495-675
Neutral position (deg)		- 3	- 3	- 3	- 3	- 3	- 3	- 4	- 4	- 4
Tilt range (deg)**		(7) - (-18)	(7) - (-18)	(7) - (-18)	(7) - (-18)	(7) - (-18)	(7) - (-18)	(3) - (-13)	(4) - (-13)	(4) - (-13)
Foot base diameter (s)		740	740	740	740	740	740	650	650	650
Chair weight (kg)		25	25	20	21.5	19.5	22	19.5	16	16.5

* According to EN1335 Class A ** Tilt range degrees (forwards) - (backwards)
Please note that these measurements are not absolute. They may vary slightly from chair to chair.

Physical Measurements - HÅG conference chairs

HÅG conference chairs are tested in accordance with EN 16139.

EN 16139 is an European Standard that specifies requirements for the safety, strength and durability of all types of non-domestic seating.

All measurements in mm. Where a chair is adjustable, minimum and maximum measurements are listed.

	HÅG Celi		HÅG Conventio Wing						HÅG Conventio		
Model:	9100	9200	9811	9821	9831	9812	9822	9832	9510/ 9520	9511/ 9521	9512/ 9522
Seat height (mm)	440	440	460	460	430				450	455	
Seat height (150 mm lift) (mm)						365-511	365-511	365-511			375-509
Chair height (mm)	810	810	900	900	900	850-1002	850-1002	850-1002	875	884	840
Seat depth (mm)	415	415	415	415	415	410	410	410	435	455	450
Chair depth (mm)	515	515	590	590	590	595	595	595	605	627	625
Seat width (mm)	430	430	425	430	430	430	430	430	385	425	425
Chair width (mm)	430	430	510	510	510	465*	465*	465*	475	516	560
Back rest inclination (deg)	14	14	14	14	14	14	14	14	14	14	14
Armrest height (mm)	230	230	245	245	245	245	245	245	230	230	230
Distance between armrests (mm)	526	526	475	475	475	475	475	475	473	513	475
Neutral position (deg)	- 3.5	- 3.5	- 1	- 1	- 1	- 1	- 1	- 1	- 5	- 5	- 5
Tilt range (deg)	(12) - (-12)	(12) - (-12)	(12) - (-11)	(12) - (-11)	(12) - (-11)	(12) - (-11)	(12) - (-11)	(12) - (-11)	(12) - (-11)	(12) - (-11)	(12) - (-11)
Foot base diameter (mm)						635	635	635			635
Chair weight (kg)	4.8	4.8	5.6*	5.6*	5.6*	7.7*	7.7*	7.7*	4.7	5.3	9.0

* Measurements without armrests

Please note that the measurements are not absolute. They may vary slightly from chair to chair.

Product Tests

Models:	ANSI/BIFMA (US)	EN 1335	EN 16139	GS (DE)	BS 5459 (GB)	NPR 1813 (NL)	EN 1729	ISO 1716 (Calorific value)
HÅG SoFi upholst.	Yes	Yes Type A		Yes	Yes	Yes*		Yes
HÅG SoFi mesh	Yes	Yes Type A		Yes	Yes	Yes		Yes
HÅG SoFi comm.	Yes		Yes	Yes				
HÅG Capisco	Yes	Yes Type A	Yes**	Yes				
HÅG Capisco Puls	Yes	Yes Type A	Yes**	Yes				
HÅG Tion		Yes Type B	Yes	Yes			Yes	
HÅG Futu solid	Yes	Yes Type A		Yes	Yes	Yes*		
HÅG Futu mesh	Yes	Yes Type A		Yes				
HÅG Futu comm.			Yes	Yes				
HÅG executive	Yes***	Yes*** Type A (Except HÅG Tribute) Type B (HÅG Tribute)		Yes*** (Except HÅG Tribute)	Yes*** (Except HÅG Tribute)			
HÅG executive meeting	Yes***		Yes	Yes***				
HÅG Creed		Yes Type A		Yes		Yes		
HÅG Creed comm.			Yes	Yes				
HÅG H03	Yes	Yes Type B		Yes				
HÅG Celi	Yes		Yes					
HÅG Conventio	Yes		Yes (Yes ¹)	Yes (Yes ¹)				
HÅG Conventio Wing	Yes		(Yes ¹)	Yes			Yes	
HÅG tablet arm	Yes		Yes	Yes				

¹ Without armrests

() Model with star base

* With 3D armrests

**Model 8001, 8002 and 8105

*** Old HÅG H09 models, renamed HÅG executive

Environmental Certificates

Environmental information	EPD (Environmental Product Declaration)	Key environmental indicators (from EPD, the figures are representing the product and its packaging)			The Nordic Swan Ecolabel	GREENGUARD Gold	Möbelfakta (SE)
		Carbon footprint (kg CO ₂ -eq)	Total energy use (MJ)	Amount of recycled materials			
HÅG SoFi 7300	Yes (Expired - new pending)	92.4	1967	45 %	Yes**	Yes	Yes
HÅG Capisco 8106	Yes	47.8	792	56 %	Yes*	Yes	Yes
HÅG Capisco Puls 8010	Yes (Expired - new pending)	39.4	672	39 %		Yes	Yes
HÅG Tion 2100	Yes	39.1	576	71 %		Yes (PP shell models)	
HÅG Futu 1200	Yes (Expired - new pending)	53.7	913	35.9 %		Yes	Yes
HÅG Inspiration 9231	Yes (Expired - new pending)	86.2	1083	38 %		Yes	Yes
HÅG Creed 6004	Yes	60.1	934	46 %		Yes	Yes
HÅG Creed 6071	No					Yes	
HÅG H03 330	No					Yes	
HÅG Celi	Yes	13.13 (model 9100) 12.19 (model 9200)	219 (model 9100) 269 (model 9200)	76 % (model 9100) 48 % (model 9200)		Yes (PP shell models)	
HÅG Conventio 9510	No				Yes (only model 9520)	Yes	Yes (only model 9520)
HÅG Conventio Wing 9811	No					Yes	Yes

An EPD (Environmental Product Declaration) is a document that summarises a product's environmental performance. An EPD is based on a life cycle assessment (LCA). The requirements for how an EPD is to be made are specified in the ISO 14025 standard. These standardised methods ensure that environmental information can be compared product by product, regardless of manufacturer, region or country. The GREENGUARD Gold Certification Standard gives assurance that products designed for use in office environments and other indoor spaces meet strict chemical emissions limits, which contribute to the creation of healthier interiors.

* Textiles: Xtreme, Nexus, Select, Note, Capture, Steelcut Trio 3. Black metal version only. All accessories comply except: Telescopic lift cover & HÅG StepUp. Not ESD version.

** Fully upholstered models. Textiles: Xtreme, Nexus, Select, Note, Capture, Steelcut Trio 3. All metal colours. All accessories comply except: Armrest leather tops & HÅG SideBack.

HÅG Fast

HÅG Fast has been put together for you in order to make it easier to choose model, fabric and colour. In the table below you can see the HÅG Fast combinations. The HÅG Fast collection offers delivery from factory in only 5-10 working days after order has been registered.

MODEL	FABRIC/COLOUR CODE									
	Xtreme Black EXR009	Xtreme Grey EXR081	Select* Black SC60999	Select* Grey SC60134	Nexus Black NEX13	Nexus Grey NEX001	FutuKnit Black FTU099/ MEH099	FutuKnit Dusk FTU102/ MEH102	Paloma Soft Black ATG56100	
HÅG H03 330	●	●	●							
HÅG Creed 6002	●		●							
HÅG Creed 6003	●		●							
HÅG Creed 6005	●		●							
HÅG Creed 6006	●		●							
Headrest HÅG Creed	●		●							
HÅG Futu 1100 mesh							●	●		
HÅG Futu 1200 solid							●	●		
HÅG Capisco 8106	●	●	●	●					●	
HÅG Capisco 8107	●		●							
HÅG Capisco Puls 8010	●	●			●	●				
HÅG SoFi 7200	●		●							
HÅG SoFi 7300	●		●							
HÅG SoFi 7500	●		●							
Headrest HÅG SoFi	●		●							
HÅG Tribute 9021			●						●	
HÅG Tribute 9031			●						●	
HÅG Conventio 9510			●							

● = Available in HÅG Fast

Please note: to be able to provide this service to all customers, there is a limit of 10 chairs per customer per day. For orders over 10 chairs, please contact Customer Service for delivery details. Please specify that your order is HÅG Fast. During holidays we may not be able to deliver HÅG Fast within the specified time frame. For more information about holiday periods, please contact Customer Service, tel: 99 50 55 00, email: info-dk@flokk.com

HÅG Fabrics and Colours (FutuKnit)

DECORATIVE STITCHING

Decorative stitching can truly add the little extra to your chair.

The 10-colour thread program is available on all textiles for the following HÅG chairs:

- HÅG Capisco model 8105, 8106 and 8107
- Available for all HÅG SoFi models, but only for seat on HÅG SoFi 7500 (with mesh back).

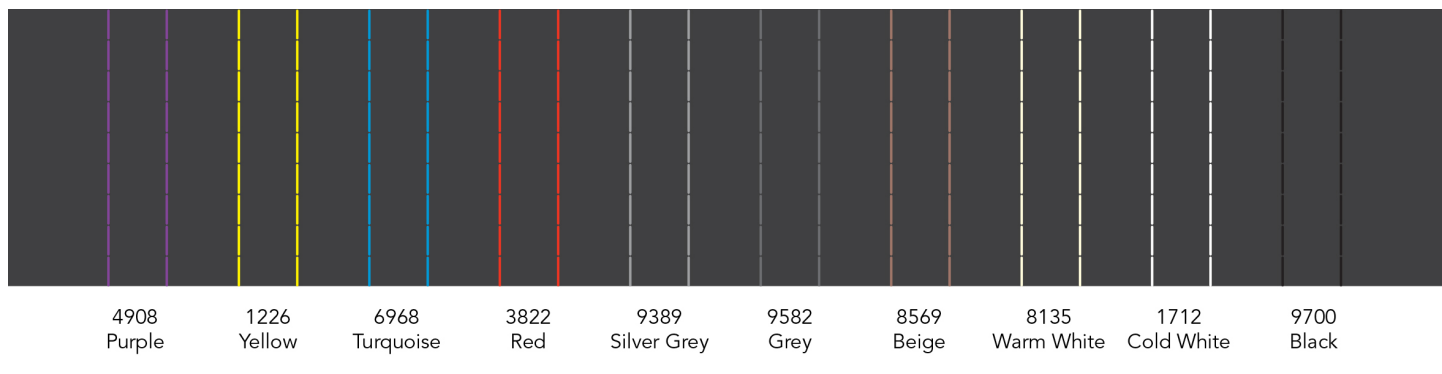

FUTUKNIT™ (CAMIRA) - PRICE GROUP DEPENDS ON CHOICE

The HÅG Futu comes in our two uniquely designed FutuKnit™ fabrics. Made from the finest quality polyester knit, combining aesthetics, ergonomics and flexibility, the 3D knitted fabrics have been technically developed to retain their tautness - providing ultimate support and comfort. By using the technical 3D knitting technique each fabric is knit in one piece that results in no waste. Both the FutuKnit solid and the FutuKnit mesh fabrics are available in seven appealing colours and can be matched. Each colour is inspired by nature.

Composition: 100% polyester

Abrasion: FutuKnit mesh > 200. 000 Martindale / FutuKnit Solid > 70. 000 Martindale

Flammability: BS EN 1021: 1-2 (Cigarette & match), BS 7176 Low Hazard, CA TB 117-2013

Light fastness: 6 (scale 1-8) (EN ISO 105-B02)

Rubbing fastness: 4-5/4-5 (Wet/Dry) (EN ISO 105X12)

Pilling: 4-5 (BS EN ISO 12945-2)

Environmental facts: EU Ecolabel, Oeko-Tex® Standard 100, 100% free of heavy metals, ISO 14001 certified company

Design: Camira Technical Knitting team & Flokk Design team

Produced in: United Kingdom

Cleaning & disinfection: Bleach cleanable (For further info follow Camira's cleaning guidelines - www.camirafabrics.com)

FutuKnit mesh and solid by Camira Fabrics are only available for the HÅG Futu collection.

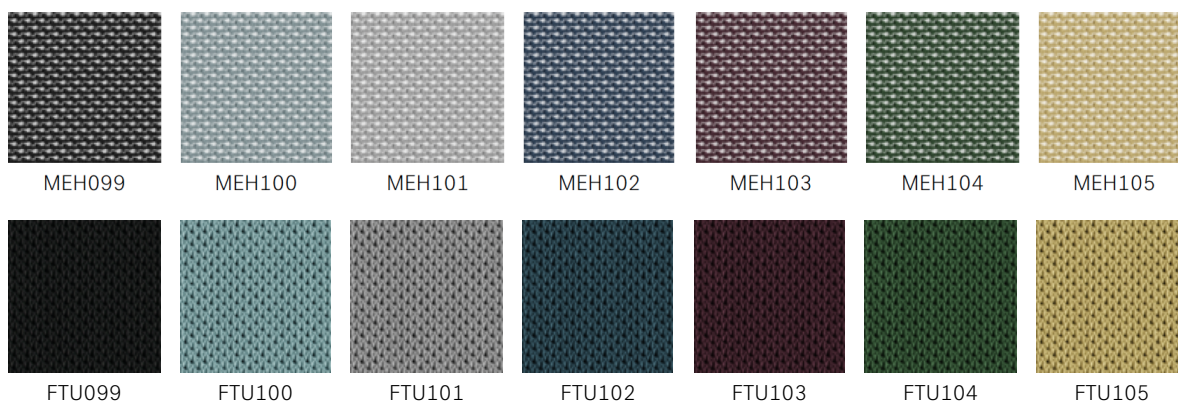

HÅG Fabrics and Colours PLASTIC & METAL

HÅG TION

HÅG Tion - Focus collection

①			③											
④									⑥				⑦	

S = Standard
E = Extended

HÅG CAPISCO PULS AND HÅG CONVENTIO WING

Matching colours for HÅG Capisco Puls
HÅG Conventio Wing

②									
---	--	--	--	--	--	--	--	--	--

*Colour variations between batches may occur

HÅG CELI

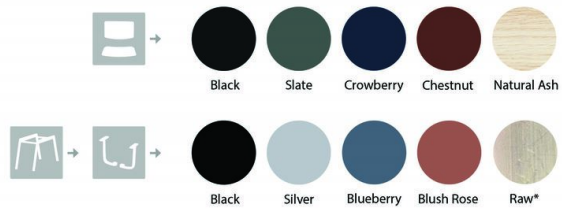

*) Raw finish: due to the production process, lines, scratches and colour changes are natural part of this finish. Raw armrests expected ready in December

CeliKnit - a 3D shape-knitted upholstery in recycled polyester offered in six colours:



HÅG SOFI



MESH (PALMHIVE) - PRICE GROUP DEPENDS ON CHOICE

A warp knitted heavy duty mesh, using an innovative yarn construction to give increased strength which provides enhanced comfort, support and appearance. Its structure is soft and comforting with a semi-transparent effect. The mesh is available in black and light grey. Easy to combine with many fabrics and colours from the Standard collection.

Composition: 100% polyester

Abrasion resistance: 150.000 Martindale

Flammability: BS EN 1021: 1 -2: 2014

Light fastness: 5 (EN ISO 105-B02)

Rubbing fastness: 4/4 (Wet/Dry) (EN ISO 105X12)

Pilling: 4-5 (EN-ISO 12945-2)

Environmental facts: Oeko-Tex® Standard 100

Produced in: United Kingdom

Mesh by Palmhive is only available for the back of HÅG SoFi 7500 and 7502

HÅG Standard fabrics & colour collection 2023

CURA (GABRIEL) - PRICE GROUP 1

Cura is a two-coloured fabric made from 98% post-consumer recycled polyester. It has a matt, slightly irregular and natural-looking texture where the dark, underlying grey fibers create a discreet yet vibrant melange effect. High durability and stretchability and its soft, voluminous touch make Cura suitable for both office and lounge furniture.

Composition: 98% post-consumer recycled polyester, 2% polyester

Abrasion resistance: 100 000 Martindale (EN ISO 12947-2)

Flammability: BS EN 1021: 1-2, BS 5852 0&1, CA TB 117-2013, ASTM E 84 Class I

Light fastness: 5-8 (EN ISO 105 - B02)

Rubbing fastness: 4-5/4-5 (Wet/Dry) (EN ISO 105X12)

Pilling: 4-5 (EN ISO 12945-2)

Environmental facts: EU Ecolabel, Oeko-Tex® Standard 100, Contains no Flame Retardant chemicals, ISO 14001 certified company

Design: Cenk Kivrikoglu

Produced in: Lithuania

Cleaning: Wash or dry cleaning. Can be disinfected with ethanol and is bleach-cleanable (For further info follow Gabriel´s cleaning guidelines – www.gabriel.dk)

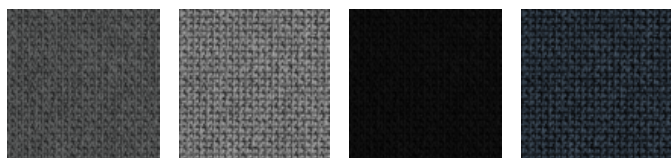

CU60109

CU60110

CU60999

CU66165

XTREME (CAMIRA) - PRICE GROUP 1

Xtreme is a crepe fabric made from 100% post-consumer recycled polyester that features exceptional Euro flammability performance. Extra stretch and structure gives an irregular, shiny finish.

Composition: 100% post-consumer recycled polyester

Abrasion resistance: >100 000 Martindale (EN ISO 12947-2)

Flammability: BS EN 1021: 1-2 (Cigarette & match), BS 7176 Low & Medium Hazard, BS 5852 Section 4 Crib 5, DIN 4102 B1, UNI 9175 Class 1 IM, NF D 60-013

Light fastness: 6 (EN ISO 105 - B02: 2013)

Rubbing fastness: 4/4 (Wet/Dry) (EN ISO 105X12)

Pilling: 5 (EN ISO 12945-2)

Environmental facts: EU Ecolabel, Oeko-Tex® Standard 100, Indoor Advantage™ "Gold", non metallic dyestuffs, ISO 14001 certified company.

Design: Camira Design Studio

Produced in: United Kingdom

Cleaning & disinfection: Washable to 60°C and bleach cleanable (For further info follow Camira's cleaning guidelines – www.camirafabrics.com)

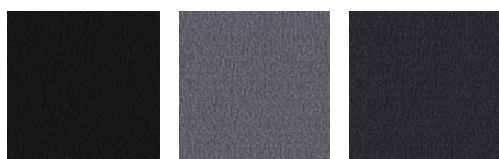

EXR009

EXR081

EXR145

SELECT (GABRIEL) - PRICE GROUP 2

Select is a classic woolen fabric with a tightly woven relief structure, combining excellent softness, stretch and durability. Its rich texture with the interplay of light and shadow add depth in all the colours in the palette.

Composition: 85% New Zealand wool, 15% polyamide

Abrasion resistance: 200 000 Martindale (EN ISO 12947-2)

Flammability: BS EN 1021: 1-2, BS 5852 0&1, BS5852 Crib 5, CA TB 117-2013, IMO MSC 307(88) Annex 1 part 8/MED registration IMO

Light fastness: 5-8 (EN ISO 105 - B02)

Rubbing fastness: 4-5/4-5 (Wet/Dry) (EN ISO 105X12)

Pilling: 4 (EN ISO 12945-2)

Environmental facts: EU Ecolabel, Oeko-Tex® Standard 100, 100% free of heavy metals, ISO 14001 certified company

Design: Cenk Kivrikoglu

Produced in: Lithuania

Cleaning: Professional dry cleaning (For further info follow Gabriel's cleaning guidelines - www.gabriel.dk)

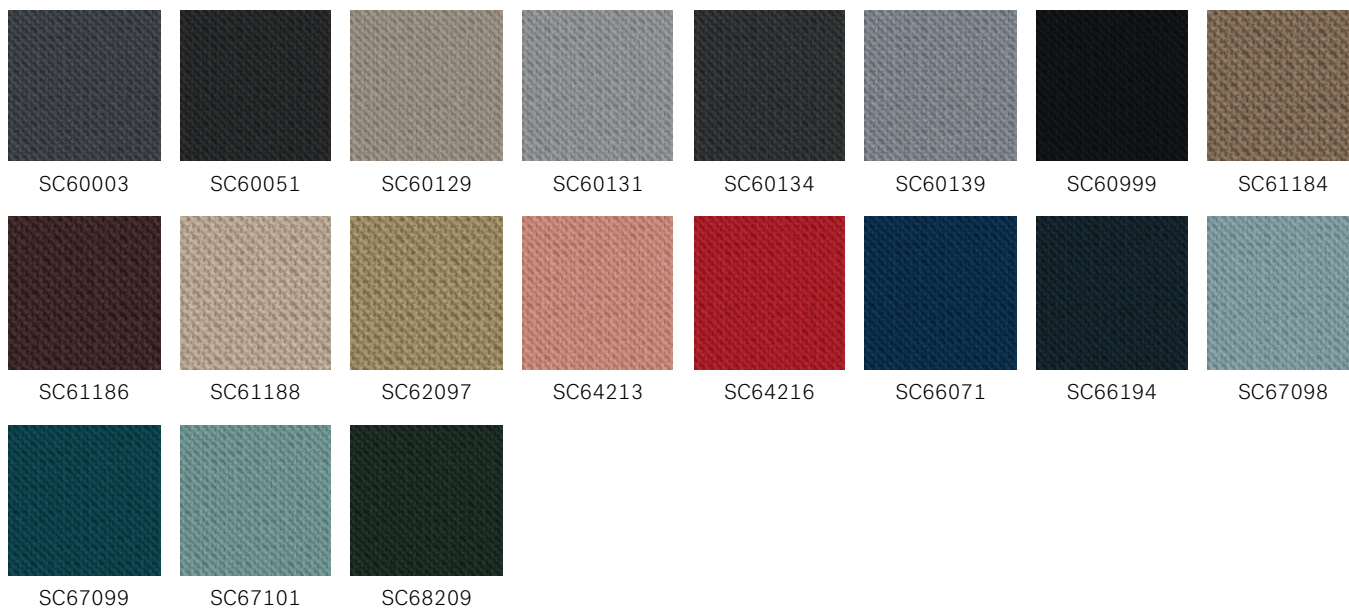

CAPTURE (GABRIEL) - PRICE GROUP 3

Capture is a lightly felted and multi-coloured wool fabric combining softness, stretch and strenght. It fuses light and dark colours to a refined melange pattern in subtle nuances, which add richness and depth to the design.

Composition: 85% New Zealand wool, 15% polyamide

Abrasion resistance: 200.000 Martindale (EN ISO 12947-2)

Flammability: BS EN 1021: 1-2 (Cigarette & match), BS 5852 Part 1 0,1 (Cigarette & match), CA TB 117-2013, Class Uno UNI 9175 Class 1 IM

Light fastness: 5-7 (EN ISO 105-B02)

Rubbing fastness: 4-5/4-5 (Wet/Dry) (EN ISO 105X12)

Pilling: 4-5 (EN-ISO 12945-2)

Environmental facts: EU Ecolabel, Oeko-Tex® Standard 100, 100% free of heavy metals, ISO 14001 certified company

Design: Cenk Kivrikoglu

Produced in: Lithuania

Cleaning: Professional dry cleaning (For further info follow Gabriel's cleaning guidelines - www.gabriel.dk)



FOCUS (GABRIEL) - PRICE GROUP 3

Focus is a woven felt fabric made of 100% long-staple worsted wool. It has an ultra soft and satiny touch combined with high strength obtained by use of high-quality worsted wool yarn and careful production processes. In addition to high durability, the fabric does not pill and will remain attractive over time regardless of wear and tear.

Composition: 100% New Zealand wool

Abrasion resistance: 100 000 Martindale (EN ISO 12947-2)

Flammability: BS EN 1021: 1-2 (Cigarette & match), BS 5852 Part 1 0.1 Cigarette and match, CA TB 117-2013, Class Uno UNI 9175 Class 1 | EMME, ÖNORM A33800-B1-B33825-Q1UK, AM 18 - NF D 60-013-(only for fabric)

Light fastness: 5-7 (EN ISO 105-B02)

Rubbing fastness: 4-5/4-5 (Wet/Dry) (EN ISO 105X12)

Pilling: 4 (EN ISO 12945-2)

Environmental facts: EU Ecolabel, 100% free of heavy metals and harmful chemicals, biodegradable, Oeko-Tex® Standard 100, ISO 14001 certified company

Design: Inger Mosholt Nielsen, colours Cenk Kivrikoglu

Produced in: Lithuania

Cleaning: Professional dry cleaning (For further info follow Gabriel´s cleaning guidelines – www.gabriel.dk)

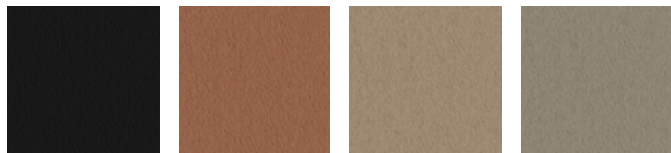

FC60999

FC61036

FC61039

FC61042

FOCUS MELANGE (GABRIEL) - PRICE GROUP 3

Focus Melange is a woven felt fabric made of 100% long-staple worsted wool. It has an ultra soft and satiny touch combined with high strength obtained by use of high-quality worsted wool yarn and careful production processes. In addition to high durability, the fabric does not pill and will remain attractive over time regardless of wear and tear. The equal thickness between the warp and weft yarn give a harmonious and symmetric melange colour expression.

Composition: 100% New Zealand wool

Abrasion resistance: 100 000 Martindale (EN ISO 12947-2)

Flammability: BS EN 1021: 1-2 (Cigarette & match), BS 5852 Part 1 0.1 Cigarette and match, CA TB 117-2013, Class Uno UNI 9175 Class 1 | EMME, ÖNORM A33800-B1-B33825-Q1UK

Light fastness: 5-7 (EN ISO 105-B02)

Rubbing fastness: 4-5/4-5 (Wet/Dry) (EN ISO 105X12)

Pilling: 4 (EN ISO 12945-2)

Environmental facts: EU Ecolabel, 100% free of heavy metals and harmful chemicals, biodegradable, Oeko-Tex® Standard 100, ISO 14001 certified company

Design: Inger Mosholt Nielsen, colours Cenk Kivrikoglu

Produced in: Lithuania

Cleaning: Professional dry cleaning (For further info follow Gabriel´s cleaning guidelines – www.gabriel.dk)

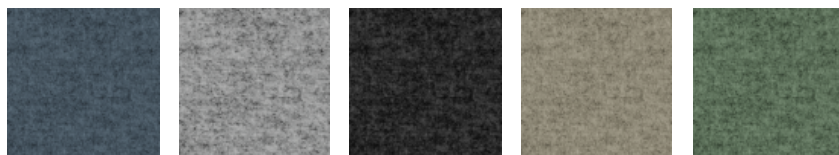

FCM60308

FCM60310

FCM60900

FCM61240

FCM68247

NEXUS (CAMIRA) - PRICE GROUP 3

Nexus is a polyester knit, offering a two dimensional stretch in a pinprick dot matrix design effect.

Composition: 100% polyester

Abrasion resistance: > 100.000 Martindale (EN ISO 12947-2)

Flammability: BS EN 1021: 1-2 (Cigarette & match), BS 7176 Low Hazard, UNI 9175 Class 1 IM

Light fastness: 5 (EN ISO 105 - B02)

Rubbing fastness: 4/4 (Wet/Dry) (EN ISO 105X12)

Pilling: 4/5 (EN ISO 12945-2)

Environmental facts: EU Ecolabel, Oeko-Tex® Standard 100, 100% free of heavy metals, ISO 14001 certified company

Design: Camira Design Studio

Produced in: Spain

Cleaning & disinfection: Washable to 60°C and bleach cleanable (For further info follow Camira's cleaning guidelines - www.camirafabrics.com)

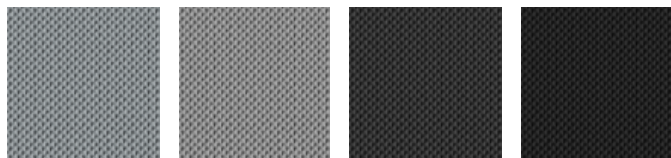

NEX001

NEX007

NEX011

NEX013

NOTE (GABRIEL) - PRICE GROUP 3

Note is a soft and lustrous worsted wool with a classic satin structure. It's sleek design highlights the furniture's shape and sharpens its silhouette.

Composition: 85% New Zealand wool, 15% polyamide

Abrasion resistance: 200 000 Martindale (EN ISO 12947-2)

Flammability: BS EN 1021: 1-2 (Cigarette & match), BS 5852 0&1, BS 5852 crib 5, IMO MSC 307 (88) Annex 1 part 8, CA TB 117-2013

Light fastness: 5-8 (EN ISO 105 - B02)

Rubbing fastness: 4/4-5 (Wet/Dry) (EN ISO 105X12)

Pilling: 4 (EN ISO 12945-2)

Environmental facts: EU Ecolabel, Oeko-Tex® Standard 100, 100% free of heavy metals, ISO 14001 certified company

Design: Inger Mosholt Nielsen

Produced in: Lithuania

Cleaning: Professional dry cleaning (For further info follow Gabriel's cleaning guidelines - www.gabriel.dk)



NT60999

OCEANIC (CAMIRA) - PRICE GROUP 3

Oceanic is made from 100 % post-consumer recycled polyester yarn where 90% are created from post-consumer plastic bottles diverted from landfill and 10% is upcycled marine plastic (from marine litter). It is a fabric born out of the SEAQUAL Initiative designed to combat marine plastic pollution and achieve a waste free environment. Oceanic has a two coloured diagonal structure with a matte surface and soft touch.

Composition: 100 % post-consumer recycled polyester, including 50% SEAQUAL yarn

Abrasion resistance: >100 000 Martindale (EN ISO 12947-2)

Flammability: BS EN 1021: 1-2 (Cigarette & match), BS 7176 Low, BS 7176 Medium Hazard with EnviroFlam5, CA TB 117-2013

Light fastness: 5 (EN ISO 105 - B02: 2013)

Rubbing fastness: 4/4 (Wet/Dry) (EN ISO 105X12)

Pilling: 4 (EN ISO 12945-2)

Environmental facts: Oeko-Tex® Standard 100, Indoor Advantage™ "Gold", non metallic dyestuffs, ISO 14001 certified company.

Design: Camira Design Studio

Produced in: United Kingdom

Cleaning & disinfection: Washable at 60°C and bleach cleanable (For further info follow Camira's cleaning guidelines - www.camirafabrics.com)

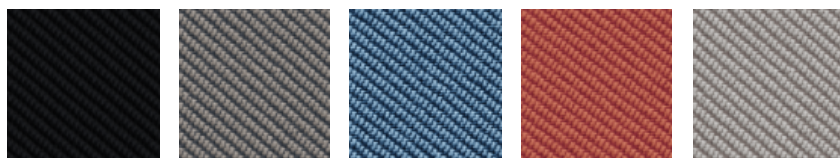

OCI001

OCI008

OCI011

OCI012

OCI014

PUXX 1 (ONIRO) - PRICE GROUP 3

PUxx 1 is a polyurethane leather with a soft touch that is easy to clean and disinfect. It is 100% waterproof, antibacterial & antifungal and resistant towards blood and urine. Being strong, durable and easy to maintain make it well suited for environments with high cleaning requirements.

Composition: Coating: 100% polyurethane with a cotton/polyester backing

Abrasion resistance: 300 000 Martindale (EN 530-2 (2010))

Flammability: BS EN 1021: 1-2 (Cigarette & match), CA TB 117-2013, BS 5852:2006 Crib 5, IMO 2010 FTP Code Annex 1 part 8

Light fastness: 6-7 (EN ISO 105-B02)

Rubbing fastness: 4-5/4-5 (Wet/Dry) (EN ISO 105X12.2016)

Environmental facts: Oeko-Tex® Standard 100, 100% free of heavy metals and harmful chemicals, ISO 14001 certified company

Design: Oniro Design team

Produced in: Belgium

Cleaning: Alcohol, hydrogen peroxide & chlorine solutions. Never use solvents. For more info please contact supplier www.oniro.nl

PUxx 1 is not available for HÅG Conventio models 9510/9511.

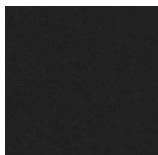

PU215816

ILLUSION (NEVOTEX) - PRICE GROUP 4

Illusion is a resistant easy cleanable synthetic leather with a polyurethane (PU) coating on a cotton backing. It has a semi matte surface with a softly grained structure and is recommended to use in environments with high cleaning demands.

Composition: Coating: 100% Polyurethane, Backing: 100% Cotton

Abrasion resistance: 500 000 Martindale (EN ISO 5470-2:2003)

Flammability: BS EN 1021: 1-2 (Cigarette & match), CA TB 117-2013, BS 5852:2006 Crib 5, DiN 4102-1B2:1998 (B2), IMO 2010 FTP Code Annex 1 part 8

Light fastness: >7 (EN ISO 105-B02)

Rubbing fastness: 4-5/4-5 (Wet/Dry) (EN ISO 105X12.2016)

Surface resistance: 4-5 (EN12720)

Environmental facts: Oeko-Tex® Standard 100, 100% free of heavy metals and harmful chemicals, ISO 14001 certified company

Design: Nevotex Design team

Produced in: Belgium

Cleaning: Alcohol (75%), hydrogen peroxide & chlorine. For specific recommendations please contact supplier www.nevotex.com

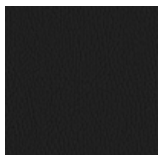

ILU110

SIRDAL (GU) - PRICE GROUP 4

Sirdal is part of the 100% Norwegian wool trio Sirdal, Suldal and Setesdal. These fabrics are uniquely short-travelled in every part of the process – 100% pure Norwegian wool manufactured in Norway. Norwegian wool with its distinctive brilliance, resilience and durability is expressed through rich structures that evoke authenticity paired with chic and modern comfort.

Composition: 100% Virgin Norwegian wool

Abrasion resistance: 57 000 Martindale (EN ISO 12947-2)

Flammability: BS EN 1021: 1-2 (Cigarette & match), IMO FTP code 2010: Part 8

Light fastness: 5-7 (EN ISO 105-B02)

Rubbing fastness: 4/4-5 (Wet/Dry) (EN ISO 105X12)

Pilling: 3-4 (EN ISO 12945-2)

Environmental facts: Locally produced, 100% free of heavy metals, ISO 14001 certified company

Design: GU design team/Ragnhild Nordhagen, Flokk Design team/Pernille Stoltze

Produced in: Norway

Cleaning: Professional dry cleaning (For further info follow GU's cleaning guidelines – www.gu.no)

Sirdal is not available for HÅG Capisco Puls models 8001/8010,



SRD120

SRD190

SRD320

SRD480

SRD630

SRD730

SRD780

SRD960

SULDAL (GU) - PRICE GROUP 4

Suldal is part of the 100% Norwegian wool trio Sirdal, Suldal and Setesdal. These fabrics are uniquely short-travelled in every part of the process – 100% pure Norwegian wool manufactured in Norway. Norwegian wool with its distinctive brilliance, resilience and durability is expressed through rich structures that evoke authenticity paired with chic and modern comfort.

Composition: 100% Virgin Norwegian wool

Abrasion resistance: > 57 000 Martindale (EN ISO 12947-2)

Flammability: BS EN 1021: 1-2 (Cigarette & match), IMO FTP code 2010: Part 8

Light fastness: 5-7 (EN ISO 105-B02)

Rubbing fastness: 4/4-5 (Wet/Dry) (EN ISO 105X12)

Pilling: 3-4 (EN ISO 12945-2)

Environmental facts: Locally produced, 100% free of heavy metals, ISO 14001 certified company

Design: GU Design Team/Ragnhild Nordhagen, Flokk Design Team/Pernille Stoltze

Produced in: Norway

Cleaning: Professional dry cleaning (For further info follow GU's cleaning guidelines – www.gu.no)

Suldal is not available for HÅG Capisco Puls models 8001/8010,

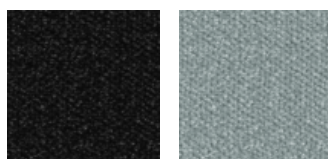

SUL180

SUL810

STEELCUT TRIO 3 (KVADRAT) - PRICE GROUP 4

Steelcut Trio 3 is a strong worsted wool and polyamide woven fabric, made with three different coloured yarns. The colours and the special weave create a three-dimensional surface where the colours seem to change depending on the angle of perspective.

Composition: 90% worsted new wool, 10% polyamide

Abrasion resistance: 100 000 Martindale (EN ISO 12947-2)

Flammability: BS EN 1021: 1-2 (Cigarette & match, AS/NZS 3837, Class 2, BS 5852 Crib 5, BS 5852 part 1, BS 5852 ignition source 3, DIN 4102 B2, ÖNORM B1/Q1,), IMO FTP Code 2010 Part 8, NF D 60 013, NFPA 260, UNI 9175 1IM, CA TB 117-2013

Light fastness: 6-7 (EN ISO 105-B02)

Rubbing fastness: 3-5/4-5 (Wet/Dry) (EN ISO 105X12)

Pilling: 4 (EN ISO 12945-2)

Environmental facts: EU Ecolabel, 100% free of heavy metals, ISO 14001 certified company, Greenguard Gold

Design: Frans Dijkmeijer, Giulio Ridolfo (updated colourways)

Produced in: United Kingdom

Cleaning: Professional dry cleaning (For further info follow Kvadrat's cleaning guidelines - www.kvadrat.dk)

Steelcut Trio 3 is not available for HÄG Capisco Puls models 8001/8010.

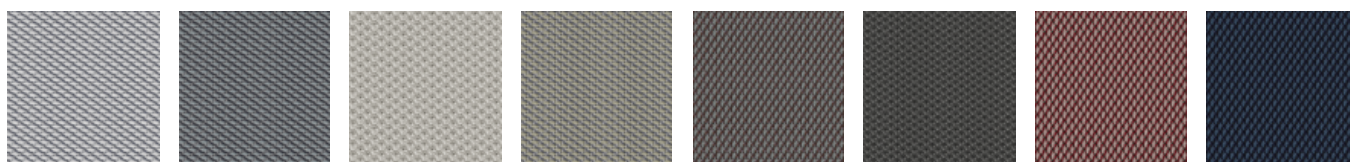

STT133

STT153

STT213

STT253

STT276

STT383

STT645

STT796

STEELCUT 3 (KVADRAT) - PRICE GROUP 4

Steelcut 3 is a unicoloured strong worsted wool and polyamide woven fabric, combining durability, soft touch and colour depth. The construction creates a three-dimensional surface resembling small pyramids or steel points. Despite its complex weaving technique, it has a simple and precise expression.

Composition: 90% worsted new wool, 10% polyamide

Abrasion resistance: 100 000 Martindale (EN ISO 12947-2)

Flammability: BS EN 1021: 1-2 (Cigarette & match, CA TB 117-2013, BS 5852 Crib 5 (with treatment), BS 5852 part 1, IMO FTP Code 2010 Part 8, NF D 60 013, NFPA 260, UNI 9175 1IM, ÖNORM B1/Q1, AS/NZS 3837 Class 2, ASTM E84 Class A Unadhered, ASTM 84 Class B Adhered

Light fastness: 5 (EN ISO 105-B02)

Rubbing fastness: 3-5/4-5 (Wet/Dry) (EN ISO 105X12)

Pilling: 3-4 (EN ISO 12945-2)

Environmental facts: EU Ecolabel, 100% free of heavy metals, ISO 14001 certified company, GREENGUARD Gold

Design: Frans Dijkmeijer, Giulio Ridolfo (updated colourways)

Produced in: United Kingdom

Cleaning: Professional dry cleaning with tetrachloroethylene, normal process (For further info follow Kvadrat's cleaning guidelines - www.kvadrat.dk)

Steelcut 3 is not available for HÄG Capisco Puls models 8001/8010.



STT190

STT655

PALOMA SOFT (WOLLSDORF) - PRICE GROUP 6

High quality semi-aniline leather. All our standard colours from Paloma have a special finish adding a particular softness to the leather. Excellent friction and breathing properties. The surface may feature small scars and marks resulting from insect bites etc. These are proof of the natural origin of the product and are part of its character.

Flammability: BS EN 1021: 1-2 (Cigarette & match), BS 5852 Crib 5, IMO A.652 (16)

Light fastness: 6 (EN ISO 105-B02)

Rubbing: Wet 80/4 - Dry 2000/4 - Sweat 50/4 - ISO 11640

Finish-adhesion: 2,0 N/cm ISO 11644

Tear-strength: 20 N/mm DIN 53329- A

Environmental facts: Tanned without using chromium salts, BlueAngel, ECO2L-certificate, ISO 14001 certified company

Produced in: Austria

Animal Welfare: All hides are by-products from the meat and dairy industries, only use hides from healthy and uninjured animal. Following European standards as a minimum and the "Five Freedoms" of livestock as defined by FAWC (Farm Animal Welfare Council)

Cleaning: Follow the leather care guide from our supplier - www.wollsdorf.com

Paloma Soft is not available for HÅG Tion model 2160 and HÅG Conventio Wing.

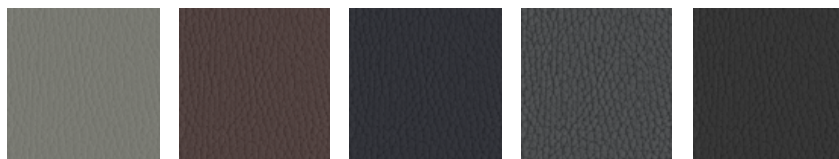

ATG55115

ATG55130

ATG55185

ATG55206

ATG56100

ELMO SOFT (ELMO) - PRICE GROUP 7

Elmosoft is a chrome free supreme quality semi-aniline grain leather from Scandinavian cattle. It is soft and pliable with an outstanding comfort and durability. Visible insect-bites and scars from healed wounds add to the authentic quality and character of the leather.

Flammability: BS EN 1021: 1-2 (Cigarette & match), BS 5852 Crib 5, CA TB 117-2013, DIN 4102 -1 (B1), IMO 2010 FTP Code Part 8 (IMO652), UNI 9175, Önorm B 3825, UNI 9175

Light fastness: 6 (EN ISO 105-B02)

Rubbing: Wet 80/4 - Dry 2000/4 - Sweat 50/4 - ISO 11640

Finish-adhesion: ≥ 2 N/cm - ISO 11644

Tear-strength: ≥ 20 N/cm DIN 53329-A

Environmental facts: 100% free of heavy metals, tanned without using chromium salts, ISO 14001 certified company, Clean water tanning technology with biological Water Treatment Plant and 100% CO2 neutral on energy.

Animal Welfare: All hides are by-products from the meat and dairy industries with traceability back to the farm, Following strict regulations on animal welfare in compliance with national and international standards as those issued by the World Organization for Animal Health (6 animal welfare freedoms)

Produced in: Sweden

Cleaning: (Follow the guidelines by our supplier - www.elmoleather.com)

Elmosoft is not available for HÅG Conventio Wing.

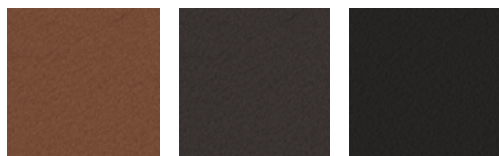

EL33004

EL93068

EL99999

Curated Fabric & Colour Collection

FLOKK & KVADRAT CURATED COLLECTION

Flokk & Kvadrat Curated Collection is a carefully selected collection of textiles and colours chosen to provide more specific and inspiring choices for our customers.

The assortment consists of five different ranges of textiles in a variety of colours and textures – each with distinct features and expressions.

The textile and colour diversity reflects high design and quality and meets the technical and environmental requirements for office interiors and public spaces.

For technical specification, product description and colour overview see website and colour card.

Curated textiles and colours in price group 3:

- **Atlas:** 131, 461, 501, 531, 571, 671, 731, 781, 911, 981
- **Re-Wool:** 128, 198, 448, 458, 558, 568, 628, 648, 718, 758, 768, 858

Curated textiles and colours in price group 4:

- **Melange Nap:** 111, 171, 191, 211, 241, 371, 411, 521, 651, 751, 911, 951

Curated textiles and colours in price group 5:

- **Twill Weave:** 190, 280, 430, 530, 780, 940, 990

For more information see our website: [Flokk and Kvadrat Curated Collection](#)



Extended Fabric & Colour Collection

With minimum 5 year guarantee

If you cannot find what you are looking for in our Standard collection, we offer a comprehensive range in our Extended collection. We offer a 10 year warranty on Xtreme, Cura, Oceanic, Focus, Focus Melange, Select, Capture, Sirdal, Suldal, Steelcut 3, Steelcut Trio 3, Nexus, Paloma Soft and Elmosoft. We offer a 5 year warranty on our polyurethane coated fabrics Illusion and PUxx 1. For more details on our warranty please see page 4. Dispatch time from factory on Extended fabrics is usually 25 - 30 working days provided fabric is available from our suppliers stock.

SUPPLIER/COLLECTION	PRICE GROUP	SUPPLIER/COLLECTION	PRICE GROUP
Bogesunds Väveri - www.bogesunds.se		GU - www.gu.no	
Global ESD	5	Amdal ⁵⁾	4
		Bardal	4
Camira Fabrics - www.camirafabrics.com		Gandal+ ⁵⁾	4
24/7+ ⁵⁾	3	Heidal ⁵⁾	4
24/7 Flax ⁵⁾	3	Hemsedal ⁵⁾	5
Blazer	3	Herringdal	4
Craggan Flax ⁵⁾	4	Morgedal ⁵⁾	4
Era	3	Redal ⁵⁾	4
Gravity	3	Romsdal ⁵⁾	4
Main Line Flax	3	Setesdal ⁵⁾	4
Nexus ¹⁾	3	Sirdal ^{1) 5)}	4
Oceanic ¹⁾	3	Suldal ^{1) 5)}	4
Sprint	3		
Synergy	3	Hornschuch - www.skai.com	
Urban	3	Evida (vinyl) ^{5) 6)}	3
Xtreme ¹⁾	3		
		Kvadrat - www.kvadrat.dk	
Elmo - www.elmoleather.com		Atlas ²⁾	3
Elmosoft Piqué ^{5) 9)}	OR	Canvas 2	4
Elmosoft ^{1) 9)}	OR	Clara 2	4
		Coda 2 ⁵⁾	OR
Gabriel - www.gabriel.dk		Divina 3 ⁵⁾	5
Breeze Fusion	4	Divina MD	5
Capture ¹⁾	3	Divina Melange 3	5
Comfort+ (polyester & polyurethane) ³⁾	5	Fiord 2	4
Connect ⁵⁾	3	Foss	5
Crisp	3	Hallingdal 65 ⁵⁾	5
Cura ¹⁾	3	Jaali	5
Fame	3	Melange Nap ^{2) 5)}	4
Focus ¹⁾	3	Pro 3 (Trevira CS)	5
Focus Melange ¹⁾	3	Raas ⁵⁾	5
Gaja C2C	3	Razzle Dazzle	6
Gaja Classic	3	Remix 3 ³⁾	4
Go Check (Trevira CS)	3	Re-Wool ²⁾	3
Harmony	3	Rime	5
Morph	3	Sisu ⁴⁾	6
Select ¹⁾	3	Steelcut 3 ^{1) 5)}	4
Step (Trevira CS)	3	Steelcut Trio 3 ^{1) 5)}	4
Step Melange (Trevira CS)	3	Sunniva	5
		Tonus ^{4) 5)}	5
		Twill Weave ^{2) 5)}	5

¹⁾ Non-standard colours

²⁾ Non-curated colours

³⁾ Not available for HÅG Tribute

⁴⁾ Only available for HÅG Tion

⁵⁾ Not available for HÅG Capisco Puls 8001 and 8010

⁶⁾ Not available for HÅG Inspiration

⁹⁾ Not available for HÅG Conventio Wing

OR = On request

SUPPLIER/COLLECTION

PRICE GROUP

Ludvig Svensson - www.ludvigsvensson.com

Balance ⁵⁾	5
Debut ⁵⁾	5
Heritage Blend	4
Heritage Botany	4
Heritage Medio	4
Heritage Tailor	4
Heritage Tuck	4
Khaki (Trevira CS)	3
Semi	3
Step ⁵⁾	4

Nevotex - www.nevotex.se

Antistatic synthetic leather (vinyl) ³⁾	3
Illusion ¹⁾ (polyurethane)	4

Oniro - www.oniro.nl

PUxx 1 ¹⁾ ¹⁰⁾ (polyurethane)	3
PUxx 2 ¹⁰⁾ (polyurethane)	3

Spradling - www.spradling.eu

Dolce (polyurethane) ⁸⁾	4
Valencia (vinyl) ⁵⁾	3

Vescom - www.vescom.com

Gamut	4
Silica (silicone)	5

Wollsdorf - www.wollsdorf.com

Paloma ⁷⁾ ⁹⁾	OR
------------------------------------	----

¹⁾ Non-standard colours

³⁾ Not available for HÅG Tribute

⁵⁾ Not available for HÅG Capisco Puls 8001 and 8010

⁷⁾ Not available for HÅG Tion 2160

⁸⁾ Not available for HÅG Capisco Puls 8002 and 8020

⁹⁾ Not available for HÅG Conventio Wing

¹⁰⁾ Not available for HÅG Conventio 9510 and 9511

OR = On request



Flokk is the leading manufacturer of high-quality workplace furniture in Europe, developing a growing family of global brands. We are the proud owner of product brands HÅG, Offecct, Giroflex, RH, Profim, 9to5 Seating, BMA, RBM, Connection and Malmstolen. A structured focus on the environment through several decades has enabled us to be a leader in the development of sustainable furniture.

Our head office is in Oslo, Norway, with main production sites in Røros (Norway), Nässjö (Sweden), Turek (Poland), Huddersfield (UK) and Hawthorne (USA). In addition, we keep sales offices in Norway, Sweden, Denmark, Germany, Belgium, the Netherlands, UK, France, Switzerland, Singapore, USA, Canada, China and Australia. Flokk products are sold in more than 80 countries worldwide. About 2000 employees work together to realize the vision of Flokk:
Inspire great work.

Flokk A/S
Sorgenfrivej 18
DK - 2800 Kongens Lyngby

Phone: +45 99 50 55 00
E-mail: info-dk@flokk.com
www.flokk.com